



Sheer  
Driving Pleasure



# THE NEW BMW X5.

**BMW EFFICIENT DYNAMICS.**  
LESS EMISSIONS. MORE DRIVING PLEASURE.



# THE NEW BMW X5.



## DIGITAL DISCOVERY: THE NEW BMW BROCHURES APP.



More information, more driving pleasure: The new BMW brochures app offers you a brand new digital and interactive BMW experience. Download the BMW brochures app for your smartphone or tablet now and explore new perspectives of your BMW.

## INNOVATION AND TECHNOLOGY.



18 Dynamics and efficiency  
19 Drivetrain and suspension.



20 Driver assistance  
21 Safety



22 Connectivity and infotainment  
23 Comfort and functionality

## EQUIPMENT.



24 Models and lines

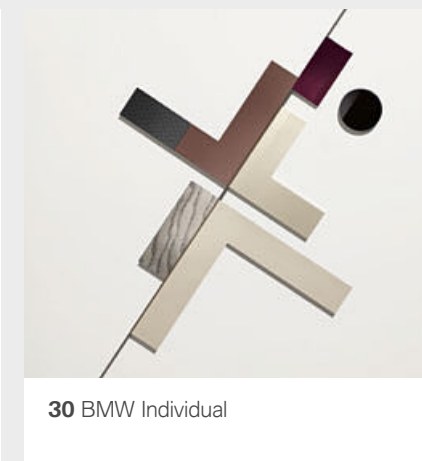

30 BMW Individual



32 Equipment highlights



36 Exterior colours

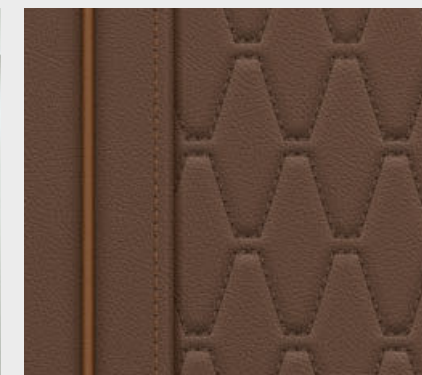

38 Interior colours



40 Wheels and tyres



41 Original BMW Accessories

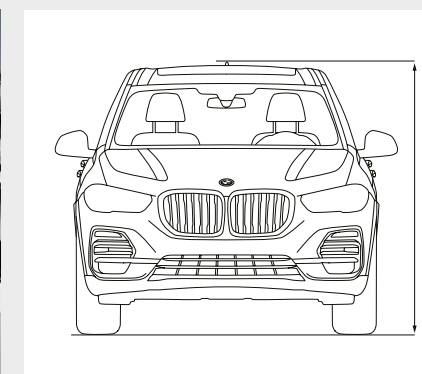

42 Technical data





---

**EVERYTHING.  
MULTIPLIED BY X.**

---





**A CHALLENGE.  
TO ALL THE OTHERS.**



**GET IN.  
AT THE HIGHEST LEVEL.**







**SOMEONE HAS  
TO BE IN CHARGE.**





**DOESN'T ASK. ACTS.**



**THERE IS NO LIMIT  
TO GREAT IDEAS.**





---

**MARK GOALS  
WITH AN X.**

---

**POWERFUL PRESENCE IN THE EXTERIOR DESIGN** DYNAMIC, FORWARD-LOOKING APPEARANCE WITH STRIKING SIDE CONTOUR II BMW LASERLIGHT<sup>1</sup> WITH X SIGNATURE II 22" LIGHT ALLOY WHEELS<sup>1</sup> **NEXT-LEVEL DRIVER ASSISTANCE AND CONNECTIVITY** DRIVING ASSISTANT PROFESSIONAL WITH EXTENSIVE SAFETY AND COMFORT FEATURES II CUSTOMISABLE BMW LIVE COCKPIT PROFESSIONAL WITH TWO 12.3" DISPLAYS II DIGITAL KEY<sup>1</sup> **LUXURIOUS FEEL, COMFORTABLE EQUIPMENT** WELCOME LIGHT CARPET II AMBIENT LIGHT AND DYNAMIC INTERIOR LIGHTING II PANORAMA GLASS ROOF SKY LOUNGE<sup>1</sup> II ELECTRIC ROLLER COVER<sup>1</sup> II TWO-PART ELECTRIC TAILGATE<sup>1</sup> **OUTSTANDING DRIVING DYNAMICS ON ANY SURFACE** BMW xDRIVE II ADAPTIVE 2-AXLE AIR SUSPENSION<sup>1</sup> AND xOFFROAD PACKAGE<sup>1</sup> II INTEGRAL ACTIVE STEERING<sup>1</sup> II ADAPTIVE M SUSPENSION PROFESSIONAL<sup>1</sup> II ACTIVE AIR STREAM KIDNEY GRILLE II EFFICIENT LIGHTWEIGHT. **KNOW YOU CAN – THE NEW BMW X5.**

<sup>1</sup> Available as optional equipment.



# DYNAMICS AND EFFICIENCY.

**BMW EFFICIENTDYNAMICS.**  
LESS EMISSIONS. MORE DRIVING PLEASURE.

## MORE POWER FROM LESS FUEL.

More power from three to 12 cylinders. Consume less, experience more – the **BMW TwinPower Turbo engines** offer the greatest possible dynamic performance with the greatest possible efficiency thanks to the newest injection systems, variable output control and sophisticated turbocharger technology. Whether diesel or petrol, and no matter how many cylinders, the engines from the BMW EfficientDynamics engine family allow markedly more agile power delivery and outstanding responsiveness even at low rpm, while being fuel-efficient and low in emissions.

## MORE DRIVING PLEASURE, LESS EMISSIONS.

Approximately 33% less CO<sub>2</sub> emissions since 2000: **BMW EfficientDynamics** is a technology package that includes not only the drive, but rather the whole vehicle concept and intelligent energy management. Provided as standard in every BMW, a variety of innovative technologies contribute to continuously improving efficiency. Via engine efficiency measures, electrification, lightweight construction methods and optimised aerodynamics, BMW has managed to reduce the CO<sub>2</sub> emissions of its fleet by 33%.

## MORE SPEED, LESS WEIGHT.

Lower weight with intelligent lightweight construction. Special consideration for every last detail – intelligent lightweight construction means that the optimal material is found and implemented for each part of the vehicle. With extremely light high-tech materials such as aluminium and carbon fibre, **BMW EfficientLightweight** is pursuing the goal of minimising vehicle weight. That leads to even more dynamic performance, increased stability and heightened vehicle safety and comfort.



## AERODYNAMICS

In the new BMW X5, extensive measures reduce aerodynamic drag, e.g. the third-generation air vent control (Active Air Stream kidney grille). Together with numerous aerodynamic optimisations, such as a targeted air flow to reduce turbulence on the front wheel or the Air Blades at the rear, consumption and CO<sub>2</sub> emissions are effectively reduced.

## ACTIVE AIR STREAM KIDNEY GRILLE

The Active air stream kidney grille opens and closes the air vents in the radiator grille according to the cooling requirements of the engine, the brakes and the air conditioning. At the same time, the system's movable kidney slats reduce air resistance when closed, thereby improving aerodynamics.

## DRIVING EXPERIENCE CONTROL INCL. ADAPTIVE MODE

The Driving Experience Control offers the driver the choice between the standard COMFORT mode, ECO PRO Mode, geared towards efficiency, and SPORT mode, which enables even more dynamic driving. The new interactive function Adaptive Mode continuously adjusts the Dynamic Damper Control, the steering and the Steptronic transmission to suit the current driving situation.

## IN THE NEW BMW X5.

# DRIVETRAIN AND SUSPENSION.



## ENGINE HIGHLIGHTS OF THE NEW BMW X5.

### X5 M50d

- M Performance TwinPower Turbo 6-cylinder diesel engine with 294 kW (400 hp) and 760 Nm torque
- Acceleration 0–100 km/h: 5.2 s
- top speed: 250 km/h<sup>5</sup>
- Combined fuel consumption: 6.8–7.2 l/100 km
- Combined CO<sub>2</sub> emissions: 179–189 g/km

### X5 40i xDrive<sup>4</sup>

- BMW TwinPower Turbo 6-cylinder petrol engine with 250 kW (340 hp) and 450 Nm torque
- Acceleration 0–100 km/h: 5.5 s
- top speed: 243 km/h
- Combined fuel consumption: 8.5–8.7 l/100 km
- Combined CO<sub>2</sub> emissions: 193–197 g/km

In the new BMW X5 – for the first time for a BMW – an xOffroad package<sup>1,2</sup> is available, with which you are always safe and smooth on the road as well as on less firm surfaces. Four selectable off-road modes adapt the all-wheel drive xDrive even more precisely to the current driving surface – for even better traction on sand, rocks, gravel or snow.

The Adaptive 2-axle air suspension<sup>1,6</sup> makes driving particularly comfortable with high driving dynamics and makes it easier to get in and out and load the vehicle. The air suspension automatically keeps the vehicle at a constant height regardless of the load. It can also be raised or lowered manually at the touch of a button.

The M Sport brake<sup>1,3,6</sup> has four-piston fixed callipers at the front and single-piston floating callipers at the rear in blue with the M designation and features larger brake discs to ensure an outstanding braking performance.

The Adaptive M suspension Professional<sup>1,6,7</sup> combines the technology of Adaptive M suspension, body roll stabilisation and Integral Active Steering. The result: the ultimate in driving stability and dynamics.

The M sport exhaust system<sup>1,3</sup> delivers a sound that can be adjusted to an even more intense engine sound with the driving dynamics buttons in the SPORT and SPORT+ programmes, while the comfort-oriented programme prioritises more discreet engine acoustics.

<sup>1</sup> Available as optional equipment.

<sup>2</sup> Not available for M50d.

<sup>3</sup> Standard for M50d.

<sup>4</sup> Expected to be available from 12/2018.

<sup>5</sup> Electronically limited.

<sup>6</sup> Only available in conjunction with additional equipment.

<sup>7</sup> Only available for xDrive50i and M50d.

The data for fuel consumption, CO<sub>2</sub> emissions and energy consumption are determined in accordance with the measurements processes as defined by European Regulation (EU) 2007/1715 in the applicable version. Data refer to a vehicle with base-level equipment in Germany, and the ranges account for differences according to the selected wheel and tyre size and the optional equipment and may change during the configuration process. Figures

have been determined on the basis of the new WLTP test cycle and have been converted back into NEDC figures for comparability. [For these vehicles, values other than those specified here may apply for the assessment of taxes and other vehicle-related charges that are (also) based on CO<sub>2</sub> emissions]. For further information on fuel consumption and CO<sub>2</sub> emissions, please see pages 42 | 43 or contact your local BMW partner.



# DRIVER ASSISTANCE.

## BMW Personal CoPilot. By your side, when you decide.

### THE INNOVATIVE BMW ASSISTANCE SYSTEMS.

Enjoy the ultimate in comfort and safety with the BMW Personal CoPilot. Whether it's for driving or parking, you can rely on BMW Personal CoPilot driver assistance systems in every situation. The most cutting-edge systems, such as radar, ultrasound and cameras, dependably register the vehicle's surroundings, forming the basis for intelligent driver assistance systems. Either activated when desired, or as emergency assistance in the background – BMW Personal CoPilot assistance systems make every journey in your BMW even safer and more enjoyable.

### CLOSER TO AUTONOMOUS DRIVING THAN EVER BEFORE.

Autonomous driving is not a utopia, it is the future: All over the world, BMW Personal CoPilot test vehicles are already driving completely independently without the driver's intervention and not only show impressively how mobility will change in the near future – they also offer an outlook on the next level of driving pleasure. Even today, BMW Personal CoPilot already offers a large number of intelligent semi-automated assistants that actively support and relieve the driver in almost every driving situation.

### SIMPLY PARK IT.

Intelligent parking assistance systems from BMW Personal CoPilot are available so that you don't just look forward to every ride in your BMW, but also to parking. For example, the Parking assistant already displays suitable parking spaces as you drive past and, depending on the BMW model, runs the parking process either partially or completely independently. But here too, automation will continue to advance, so that in the future it will be possible for vehicles without drivers to search for a parking space and execute the parking process autonomously.

### DRIVING ASSISTANT PROFESSIONAL

Driving Assistant Professional<sup>1,2</sup> offers optimum comfort and maximum safety during lots of critical or monotonous driving situations with Steering and lane control assistant, Lane Change Assistant, Emergency Stop Assistant, local hazard warning, Lane Keeping Assistant with active side collision protection and other safety functions.

### CROSSROADS WARNING WITH BRAKE INTERVENTION

The Crossroads warning with city braking<sup>3</sup> function detects traffic lights, traffic signs and vehicles crossing and can avoid accidents. If a collision cannot be avoided, the system helps to reduce the impact speed.

### REVERSING ASSISTANT

The Reversing Assistant<sup>4</sup> stores the last 50 m of the driven path in forward travel up to 35 km/h, so that it can be retracted if required. You are relieved of the steering work and can concentrate on monitoring the vehicle environment.

## IN THE NEW BMW X5.

The key visual for BMW Personal CoPilot shown here is an exemplary, artistic representation, which can deviate from the design and equipment of the BMW model described in this medium.

# SAFETY.

■ Standard equipment □ Optional equipment

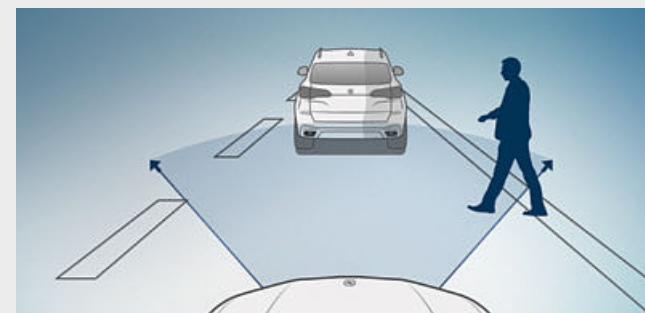

□ With Active Guard Plus<sup>3</sup>, the vehicle is equipped with an extended warning or emergency braking system. In addition to a front camera, it also uses a radar to detect vehicles, pedestrians and cyclists. The system detects cyclists and pedestrians at up to 85 km/h and vehicles at up to 210 km/h. In an emergency, emergency braking is initiated. A warning is issued at speeds of up to 250 km/h.

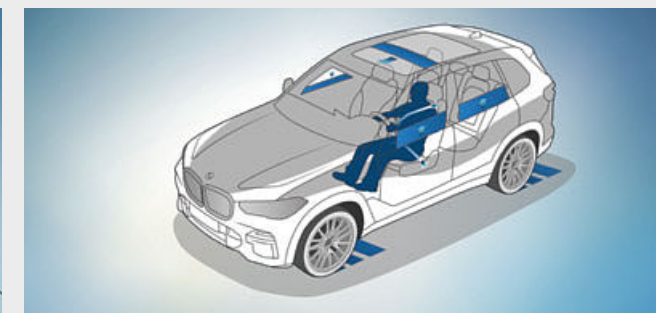

□ Active Protection is the BMW ConnectedDrive preventive passenger protection system. Safety belts are pretensioned in critical situations, electric seats are returned to upright positions and the windows and sliding roof are closed. After an accident occurs, the brakes are automatically applied until the car reaches a standstill.

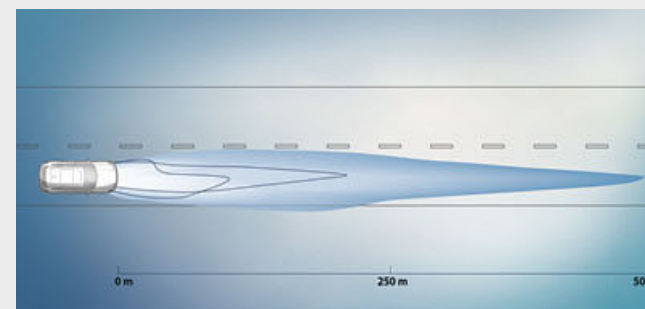

□ In laser high-beam mode, BMW Laserlight in a unique X design illuminates a range of up to 600 m, nearly twice as far as that of conventional headlights. Better visibility in the dark significantly increases safety. The blue X signature and the "BMW Laserlight" lettering underline the vehicle's technological standards.

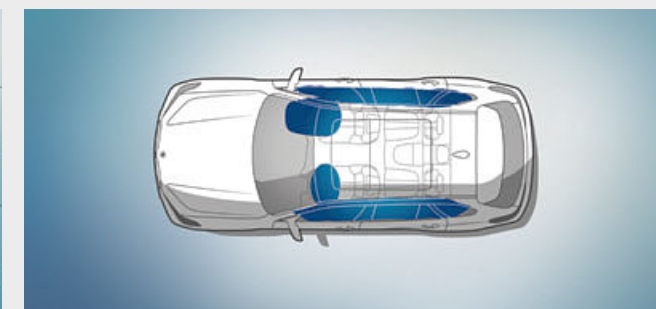

■ Airbags for driver and front passenger are part of the optimally coordinated safety components in a BMW. Overall, six airbags provide targeted protection: the driver and front passenger airbags, the head airbags for the entire window surface on the side, and the side airbags integrated into the front seat backrests.

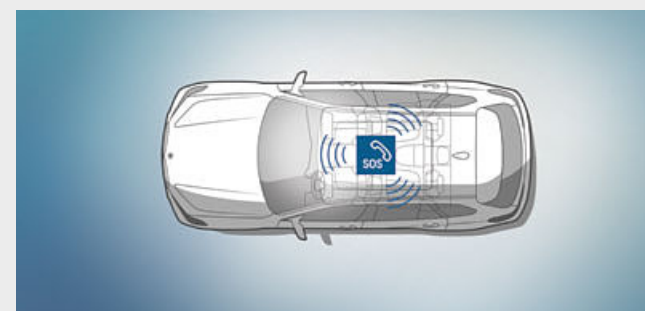

■ If there is an accident, time is of the essence. Intelligent Emergency Call gets help and can even save lives in case of an emergency. It contacts specially trained call centre agents who offer support to you and your passengers until the emergency services arrive. The first responders also receive important information directly. The term is indefinite.

<sup>1</sup> Available as optional equipment.

<sup>2</sup> Function may be limited in darkness, fog or bright glare.

<sup>3</sup> This feature is part of Driving Assistant Professional.

<sup>4</sup> Part of the Parking Assistant or Parking Assistant Plus packages.

Some ConnectedDrive Services may differ between countries. Please consult your local BMW partner for more information.



# CONNECTIVITY AND INFOTAINMENT.

## BMW ConnectedDrive Connected to be free.

### CONNECTED FOR OVER **40** YEARS.

Focused on the future – from the very beginning. By the 1970s, BMW had already made headway in connected mobility. Another milestone of the digital future was surpassed in 1999: vehicles with built-in SIM cards. Then came the first online functionality, Google Services and innovative display systems such as the BMW Head-Up Display. Throughout this process, the desires of the customer have always taken centre stage. As the first premium automobile manufacturer, BMW makes it possible to book and pay for services flexibly via the BMW ConnectedDrive Store, in the vehicle or on a computer at home. And with the introduction of BMW Connected and the Open Mobility Cloud, BMW is taking the next steps into the future of mobility.

### MORE THAN **20** SERVICES IN THE BMW CONNECTED DRIVE STORE.

ConnectedDrive Services open the gate to the digital world of BMW. Use vehicle apps such as news, weather, office or online search on the go and be well informed at all times. ConnectedDrive Services form the basis to order further digital services such as Concierge Services or Online Entertainment from the ConnectedDrive Store – always, everywhere, simply and flexibly.

### IN TOUCH **24/7** WITH BMW CONNECTED.

Are the doors of my car really locked, when should I leave my office to arrive in time for dinner at the fancy Italian restaurant and how will I find my way there? As your personal mobility assistant, the BMW Connected App can easily help you with all these questions. It connects you directly with your car, giving you access before and during your trip to numerous functions, which make every drive simpler and more comfortable.



#### PARKING PLACE ASSIST

Trying to find a parking space close to your destination? This is an easy task with the Parking Space Assistant<sup>1</sup>. It suggests vacant spaces in large parking facilities or on the street and, based on your selection, finds the best route for you with the highest likelihood of an available space. You can also pay for parking cash-free using ParkNow. The term is three years.

#### DIGITAL KEY

Why put your key in the ignition if you have your Android smartphone with you? The Digital Key<sup>1,2,7</sup> allows you to lock and unlock your BMW and even start the engine without needing a physical key. It can be downloaded to your Android smartphone using the BMW Connected app and shared with family and friends. The term is one year.

#### REMOTE SOFTWARE UPGRADE

Do you want your BMW to be up to date with the latest software? With Remote Software Upgrade, your BMW will always be like new. Convenient, reliable and stress-free – without having to visit your BMW service partner. Upgrades are installed over-the-air, just as they are for your smartphone.

## IN THE NEW BMW X5.

<sup>1</sup> Requires BMW ConnectedDrive Services.  
<sup>2</sup> Part of the Comfort access package.

<sup>3</sup> Available as optional equipment.  
<sup>4</sup> Only available in conjunction with additional equipment.

Some ConnectedDrive Services may differ between countries. Please consult your local BMW partner for more information.

# COMFORT AND FUNCTIONALITY.



The Panorama glass roof Sky Lounge<sup>3</sup> creates a generous sense of space during the day, while at night it lends an atmospheric mood with a light design consisting of more than 15,000 light elements. The light design can be switched between six Ambient light colours.

The temperature-controlled<sup>3</sup> cupholders in the centre console can individually cool or keep stored beverages warm. The temperature control is activated via buttons on the left and right. The ambient lighting also indicates the function (blue for cooling or red for heating).

The Comfort access system<sup>3</sup> makes it possible to open all of the vehicle doors without using the key and to start the vehicle by pressing a button, while the key remains in the pocket. The tailgate can be opened and closed without even being touched with a quick wave of the foot under the rear bumper. Additionally, the Digital Key<sup>1,7</sup> can be operated on a smartphone to access and start the vehicle.

Both the upper and the lower<sup>2,3</sup> part of the tailgate can be opened and closed electrically. This facilitates access and loading of the luggage compartment. The lower part of tailgate can also be used as a practical seat.

The Ambient Air Package<sup>3</sup> comprises a fragrance dispersal function and an air ionisation function. There are eight fragrances to choose from, all specially composed for the vehicle.

The third row of seats<sup>3,4,5</sup>, with two individually foldable and forward-facing seats, offer room for two additional passengers. To ensure easy access, the second row of seats can be folded forwards with the Easy-Entry function.

The Massage function for driver and passenger<sup>3,4</sup> improves the physical wellbeing by stimulating or relaxing certain muscle groups. There are eight massage programmes dedicated to different parts of the body.

The Travel & Comfort system<sup>3</sup> includes two additional USB ports (type C) and a preparation for two multifunctional holders in the rear of the vehicle. Tablets, clothes hangers or folding tables, for example, can be attached to them.<sup>6</sup>

<sup>5</sup> Expected to be available from 12/2018.

<sup>6</sup> Various Travel & Comfort components are available through Original BMW Accessories for the multifunctional holder due to the modular design of the plug-in coupling.

<sup>7</sup> Equipment optionally available for selected Samsung smartphones. Included in the optional "Comfort access system". Alternatively, you have the possibility to open and start the car via a key card from Q4 2018.



# BASE.

Discover more with the new BMW catalogue app. Now available for your smartphone and tablet.



■ The slim-modelled instrument panel and the pronounced command position ensure optimum overview of the driving situation at all times. The Sport leather steering wheel feels good in your hands, and the Aluminium 'Mesh effect' dark interior trim finishers set visual highlights.

■ The standard Sport seats for driver and front passenger have multiple electrical adjustment options and ensure a particularly good seating position and optimum lateral support. The standard leather 'Vernasca' with design perforation, shown here in Canberra Beige, gives the interior a particularly high-quality look.

## Selected base model equipment features:

- 18" light alloy wheels
- LED headlights
- BMW Live Cockpit Professional
- Sport leather steering wheel
- Sport seats for driver and front passenger
- 2.5-zone automatic air conditioning
- Steptronic transmission
- Adaptive suspension
- Rear seat backrest with 40:20:40 division
- Ambient light incl. dynamic interior light



■ 18" light alloy wheels V-spoke style 618 in Reflex Silver, wheel size 8.5J x 18, with 255/55 R18 tyres.

# XLINE.

Equipment 24 | 25

■ Standard equipment □ Optional equipment



□ The combination of Sport leather steering wheel and the open-pored fine-wood trim in poplar grain light anthracite-brown has a sporty-elegant effect. The air conditioning and radio control units as well as the air vents are additionally enclosed with galvanic elements and further enhance the dashboard visually.

□ Comfort seats with electrical adjustment allow a perfect seating position. Upholstered in high-quality leather 'Vernasca' Ivory White' with design perforation, they have a luxurious look.

■ 19" light alloy wheels V-spoke style 735 in Ferric Grey, wheel size 9J x 19 with 265/50 R19 tyres.

## xLine exterior equipment:

- BMW kidney grille with exclusively designed vertical slats with front sides in aluminium with satinised look, grille frame in Pearl Chrome
- 19" light alloy wheels V-spoke style 735; other wheels available
- BMW Individual Exterior Line aluminium with satinised look, alternatively BMW Individual high-gloss Shadow Line
- Specific air inlets in aluminium with satinised look
- Air Breather in Pearl Chrome with surround in aluminium with satinised look
- Specific grilles in the front lateral air inlets in black high-gloss
- Exclusive water-catching strip in the A-pillar in black high-gloss
- Side skirts trim with trim strip in aluminium with satinised look
- Sump guard front and rear in stainless steel styling
- Active air stream kidney grille with accent bar in Aluminium with satinised look
- Tailpipe trims in aluminium with satinised look
- BMW Individual roof rails aluminium with satinised look, alternatively BMW Individual roof rails high-gloss Shadow Line

## xLine interior equipment:

- Door sill finishers in aluminium with "BMW xLine" lettering
- Car key with chrome clasp



# M SPORT PACKAGE.

Discover more with the new BMW catalogue app. Now available for your smartphone and tablet.

powered by 

■ Standard equipment □ Optional equipment



□ The high-quality and high-grip M leather steering wheel with multifunction buttons is an eye-catcher. The interior trim finishers in fine-wood trim 'Fineline Stripe' brown give the interior an exclusive atmosphere. The clear instrument panel defined by long lines creates a wide-ranging effect in the interior.



□ The comfort seats in optional BMW Individual leather trim 'Merino' in Coffee enhance the sporty atmosphere. The diverse electrical adjustment options make it easier for the driver and front passenger to quickly find an ergonomically perfect sitting position.

## M Sport package exterior equipment:

- M Aerodynamics package with front apron, side skirts and wheel arch trims in body colour
- LED fog lights
- 20" M light alloy wheels Star-spoke style 740 M Bicolor with mixed tyres and runflat tyres; other wheels available
- Adaptive M suspension
- Steptronic Sport transmission
- BMW Individual high-gloss Shadow Line, alternatively BMW Individual Exterior Line Aluminium satinised
- M designation on the sides
- M sport brake with blue painted brake callipers with M designation
- Rear apron with diffuser insert
- Tailpipe finishers in M Sport package-specific geometry
- Exclusive paintwork in Carbon Black metallic; other paintworks available
- BMW Individual roof rails high-gloss Shadow Line
- Welcome Light Carpet

## M Sport package interior equipment:

- M door sill finishers, illuminated, M footrest and M-specific pedals
- Sport seats for the driver and front passenger in Black Vernasca leather with contrast stitching; other upholsteries available
- M Leather steering wheel
- BMW Individual headliner anthracite
- Interior trim finishers in Aluminium Tetragon, other trims available
- Instrument cluster with M specific display in SPORT and SPORT+ mode
- M Sport package-specific car key
- M-specific floor mats in velour<sup>1</sup>



□ 21" M light alloy wheels Y-spoke style 741 M Bicolour Orbit Grey with mixed tyres, burnished, front 9.5J x 21 with 275/40 R21 tyres, rear 10.5J x 21 with 315/35 R21 tyres.



□ 22" M light alloy wheels Double-spoke style 742 M Bicolor jet black with mixed tyres, burnished, front 9.5J x 22 with 275/35 R22 tyres, rear 10.5J x 22 with 315/30 R22 tyres.



■ Exclusive doorsill finishers with M model designation provide a sporting welcome when the doors are opened.



■ The 8-speed Steptronic Sport transmission offers incredibly sporty gear changes, both automatically and manually via the gearshift paddles or selector lever.

<sup>1</sup> Only available in conjunction with Leather 'Vernasca' Black with contrast stitching.



# THE NEW BMW X5 M50d.



The M aerodynamics package with specific front and rear aprons and side skirts, all in body colour, gives the BMW X5 M50d a distinctly sporty look. The design of the rear bumper cover in Dark Shadow metallic makes another sporting statement.



The BMW X5 M50d offers outstanding precision and agility. The dynamic characteristics are increased, and intensive driving pleasure assured, thanks to the M Performance-specific calibration of the suspension, the variable sport steering, the standard M Sport brake, the M Sport differential and the M Sport exhaust system.



The M leather steering wheel including multifunction and M emblem features the three-spoke design. With a steering wheel rim and contoured thumb rests, it provides a direct, athletic steering experience.



As soon as the doors are opened, the exclusive doorsill finishers with M model designation signal the sporting DNA of the vehicle.



The „M50d“ model designation in Cerium Grey is positioned on the right at the rear and further underscores the exclusivity of the BMW X5 M50d.



# BMW INDIVIDUAL.

THE EXPRESSION OF  
PERSONALITY.



## THE NEW BMW X5 – INSPIRED BY BMW INDIVIDUAL.



The BMW Individual doorsill finisher with illuminated lettering and the BMW Individual interior trim finishers in piano finish Black lift your new BMW X5 to a special level: yours.

## INDIVIDUALITY IS A MATTER OF CHOICE.

If someone decides, then you: BMW Individual offers you all the options to customise the new BMW X5 according to your wishes, with the degree of customisation entirely up to you. Add your personal driving experience to the typical BMW driving pleasure. Choose what suits you the most from particularly high-quality equipment options:

Exclusive BMW Individual paint finishes that show style and confidence. Soft, voluminous leather trims and interior trim finishers made of fine woods, which turn the interior into your personal comfort zone. Or go your very own way, only following your ideas – BMW Individual ensures that they become an automotive reality.

You are not looking for special, but unique?  
No matter what you are looking for,  
BMW Individual has the know-how and skills to  
make your wishes come true.

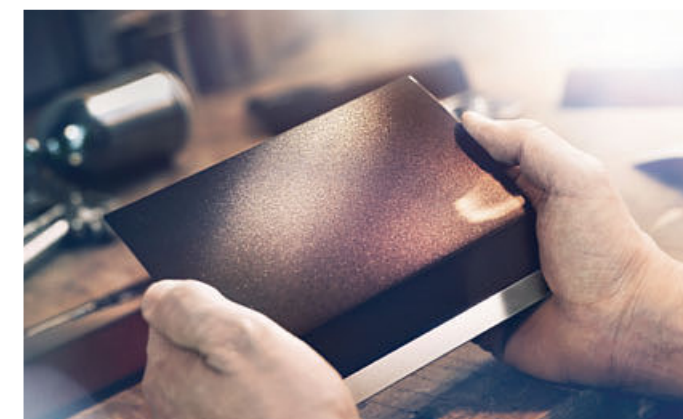

DISCOVER THE WHOLE RANGE OF BMW INDIVIDUAL EQUIPMENT FOR THIS MODEL.  
WITH THE BMW CATALOGUES APP FOR IOS AND ANDROID.



# EQUIPMENT HIGHLIGHTS.

Discover more with the new BMW catalogue app. Now available for your smartphone and tablet.

■ Standard equipment □ Optional equipment



□ In laser high-beam mode, BMW Laserlight in a unique X design illuminates a range of up to 600 m, nearly twice as far as that of conventional headlights. Better visibility in the dark significantly increases safety. The blue X signature and the "BMW Laserlight" lettering underline the vehicle's technological standards.



■ Dynamic and comfortable: The individually adjustable Sport seats for the driver and front passenger feature numerous electric adjustment options, including backrest width and seat angle. Together with adjustable thigh support, the taller seat and backrest bolsters provide excellent ergonomics and more lateral support during fast cornering.



□ The Aluminium running board<sup>1</sup> with a brushed, anodised surface and rubber inserts adds a particularly distinctive touch and makes getting in and out of the vehicle more convenient.



□ When open, the Panorama glass roof provides a great deal of fresh air. Closed, it creates a bright, light-flooded atmosphere in the interior. It opens and closes completely automatically at the push of a button, or remotely, and is equipped with slide and lift functions, roller sunblind and wind deflector.



□ The M Leather steering wheel including multifunction buttons<sup>2,3</sup>, an M badge and an integrated driver-side airbag is featured in three-spoke design. With a steering wheel rim in leather 'Walknappa' Black with black stitching and contoured thumb rests, it provides a direct, athletic steering experience.



■ Ambient light, including Ambient contour lighting in the front and rear doors, creates a relaxed, cosy lighting atmosphere in the interior. The Welcome Light Carpet illuminates the area in front of the car doors when entering and exiting. Six dimmable light designs in White, Blue, Orange, Bronze, Lilac and Green are available.



□ The Roof rails in Aluminium satinated provide the base for a multifunctional BMW roof rack unit.



□ The Soft-Close function pulls the slightly-open door shut automatically and nearly silently.



□ Perfectly fitted and both dirt-repellent and water-resistant, the Floor mats in velour<sup>2</sup> protect the carpet, make cleaning easier and create a high-quality appearance.



□ The Trailer tow hitch with electrically adjustable tow ball and trailer stability control is approved for heavy loads of up to 3.500 kg.



■ The black Sport leather steering wheel<sup>1</sup> with a thick rim and contoured thumb rests has an exceptionally pleasant, high-grip feel.

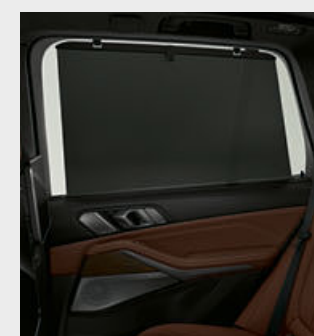

□ The manually operated roller sunblind for the rear side windows protects the interior from sunlight and offers privacy.



□ The lumbar support for the driver and front passenger seats can be adjusted both vertically and laterally, allowing for an orthopaedically optimised seating position.

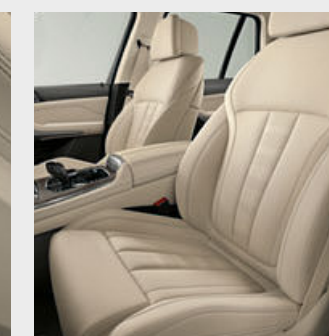

□ The seat heating increases the temperature of the seat and backrest surfaces of the front seats as well as the exterior rear seats. It can be individually regulated to three levels for each seat.

<sup>1</sup> Not available for M50d.

<sup>2</sup> Standard for M50d.

<sup>3</sup> Only available in conjunction with additional equipment.



# EQUIPMENT HIGHLIGHTS.

Discover more with the new BMW catalogue app. Now available for your smartphone and tablet.

■ Standard equipment □ Optional equipment



□ The tonally outstanding Harman Kardon surround sound system features a 464 W digital amplifier, nine channels and 16 speakers. Its sophisticated sound perfectly fills the interior space. Vehicle-specific, speed-dependent equalising precisely compensates for any background driving noise.



□ Telephony with wireless charging<sup>1</sup> incorporates a wireless charging dock and a second microphone for a better hands-free voice quality for you and your front passenger. A roof aerial connection improves mobile reception. Two mobile telephones and an audio player can be connected simultaneously via Bluetooth. Also included is the technical capacity for a WiFi hotspot.



■ The BMW Live Cockpit Professional with navigation function<sup>6</sup> includes a high-quality display network consisting of a high-resolution 12.3" Info Display that can be operated by touch and a fully digital 12.3" instrument cluster.

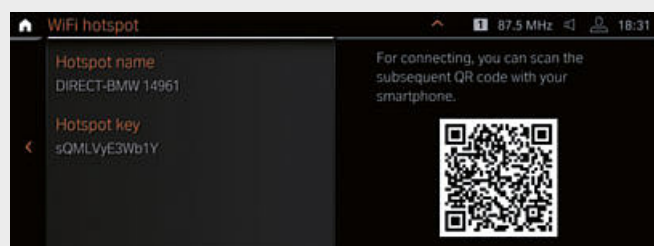

□ Take part in video conference calls on your tablet or stream the final episode of your favourite series on your smartphone. The Wi-Fi<sup>2,3</sup> Hotspot is a way to go online with LTE speed (if available) using the SIM card installed in your vehicle. You and your fellow passengers can surf the Web on up to ten devices.



□ The Automatic air conditioning with 4-zone control allows individual climate comfort for the driver and front passenger, as well as for the right and left rear passengers.



□ The top of the BMW Individual instrument panel is covered in leather 'Walkappa' Black. The sophisticated aesthetic of this high-quality trim gives the interior an even more luxurious feel.

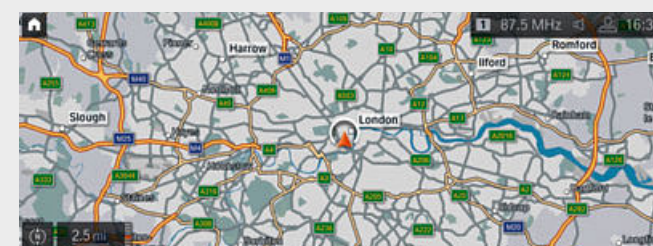

■ Traffic Information provides drivers with up-to-date information from the Traffic Message Channels (TMC) via radio.

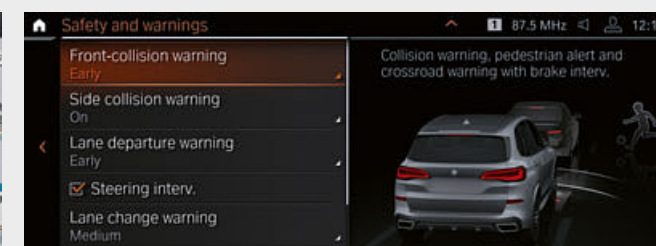

□ The safety package Driving Assistant<sup>7</sup> includes the camera-based systems approach control warning and person warning with full city braking function, Speed Limit Assist incl. Speed Limit Info with No-overtaking indicator with preview and Lane Departure Warning. Additionally, the radar-based equipment includes Crossing traffic warning rear, Lane Change Warning and Rear collision warning.

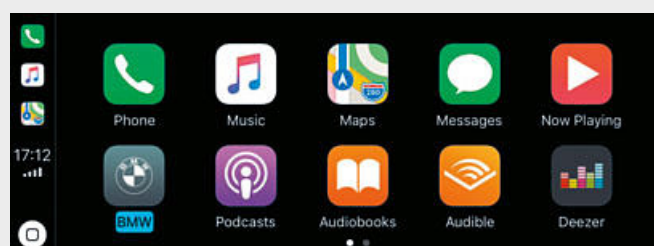

□ Why go without the features of your iPhone in your BMW when you can continue<sup>4,5</sup> operating it as usual? The preparation for Apple CarPlay<sup>®</sup> gives you remote access to telephony as well as apps like iMessage, WhatsApp, TuneIn, Spotify and Apple Music. You can also use the voice button on the steering wheel to access Siri, Apple's voice assistant. The term is three years.

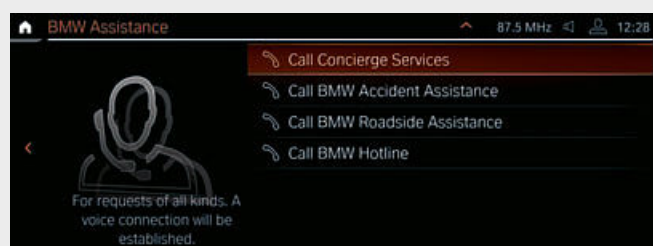

□ Concierge Services<sup>4</sup> are always there for you when you are on the move – personally, around the clock and 365 days a year, be it at home or abroad. Your call centre agent will help you with any questions or needs that may arise while you are on the go.

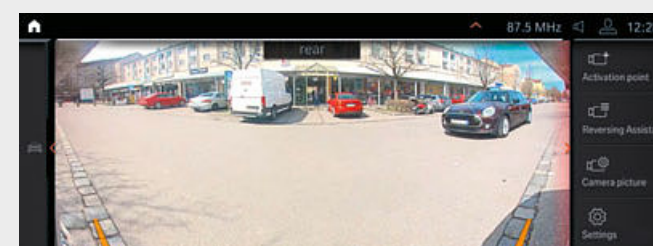

□ The Crossing traffic warning<sup>8,10</sup> rear warns you of crossing traffic when pulling out of perpendicular parking spaces. The system works up to a speed of 7 km/h and can be activated and deactivated via the "Park" setting menu.

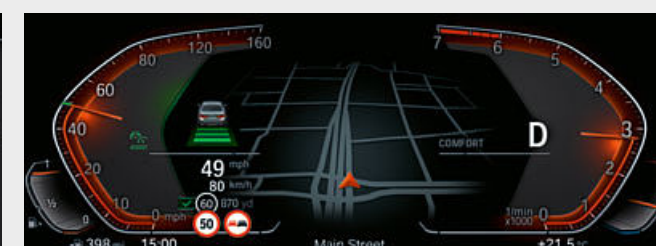

□ The automatic Speed Limit Assist<sup>9</sup> adapts the Active Cruise Control dynamically to upcoming speed limits. These are determined along the probable route by the navigation system and checked by the camera. The information provided is continuously updated by the entire fleet.

<sup>1</sup> Supports inductive charging for Qi-compatible mobile phones. Special charging cases are available from Original BMW Accessories for selected smartphones that do not support the Qi standard for inductive charging.

<sup>2</sup> The WiFi hotspot fulfils all in-vehicle requirements for use of the internet with the maximum LTE standard. Usage is subject to cost.

<sup>3</sup> Only available in conjunction with additional equipment.

<sup>4</sup> Part of the ConnectedPackage Professional equipment.

Some ConnectedDrive Services may differ between countries. Please consult your local BMW partner for more information.

<sup>5</sup> Apple CarPlay<sup>®</sup> compatibility and supported functions depend on the model year and the software installed on the iPhone<sup>®</sup>. When the Apple CarPlay<sup>®</sup> preparation is in use, selected vehicle data is transferred to the phone. The mobile phone manufacturer is responsible for any further processing of the data.

<sup>6</sup> As part of BMW ConnectedDrive, in selected European countries, the system automatically updates maps for three years up to four times per year without incurring licensing fees.

<sup>7</sup> Function may be limited in darkness, fog or bright glare.

<sup>8</sup> Part of the Driving Assistant and Driving Assistant Professional packages.

<sup>9</sup> Part of the Driving Assistant Professional package.

<sup>10</sup> Real picture displayed on the Control Display only in conjunction with Parking Assistant or Parking Assistant Plus packages.



# EXTERIOR COLOURS.

Discover more with the new BMW catalogue app. Now available for your smartphone and tablet.

■ Standard equipment □ Optional equipment

## M SPORT PACKAGE

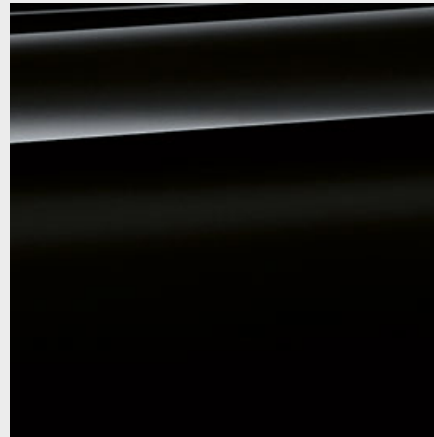

■ **Non-metallic** 668 Black<sup>1</sup>



■ **Non-metallic** 300 Alpine White<sup>2</sup>

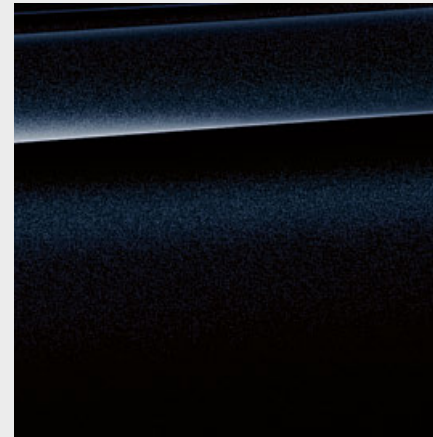

□ **Metallic** 416 Carbon Black<sup>4</sup>

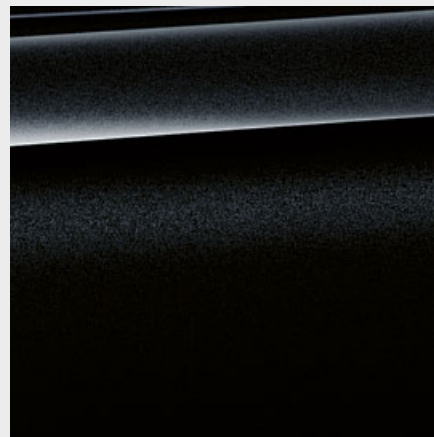

□ **Metallic** 475 Black Sapphire<sup>5</sup>



□ **Metallic** A96 Mineral White<sup>5</sup>

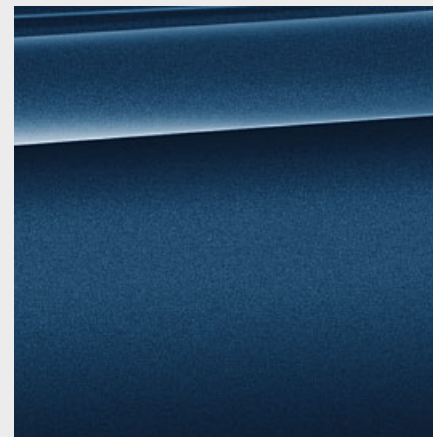

□ **Metallic** C1M Phytonic Blue<sup>5</sup>

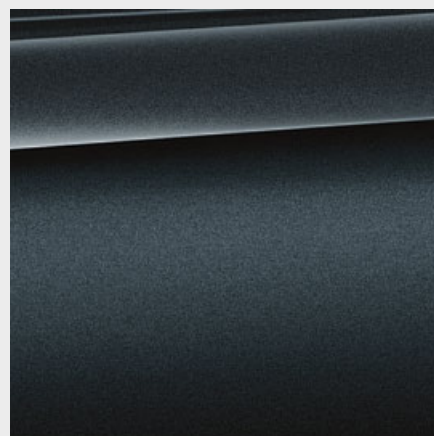

□ **Metallic** C27 Arctic Grey brilliant effect<sup>5</sup>

## BMW INDIVIDUAL



□ **BMW Individual** C1N Sunstone metallic.<sup>3,5</sup>

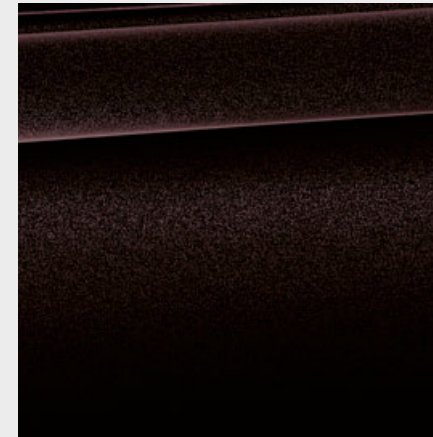

□ **BMW Individual** X03 Ruby Black metallic<sup>5</sup>

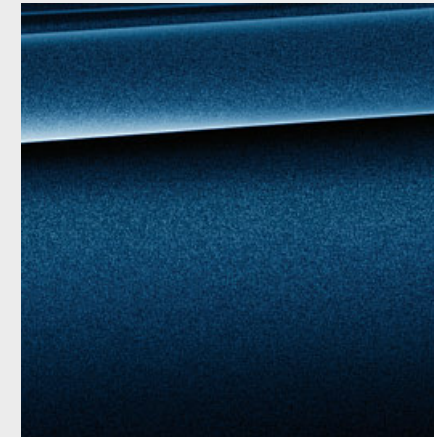

□ **BMW Individual** X10 Tanzanite Blue metallic<sup>6</sup>

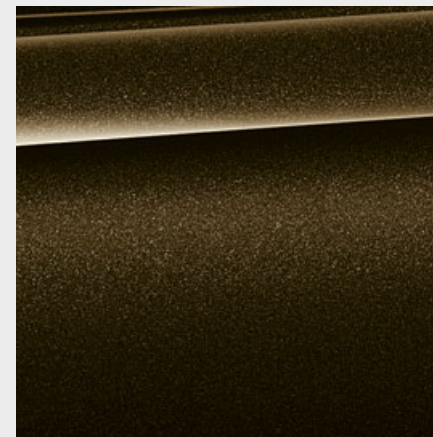

□ **BMW Individual** X13 Pyrite Brown metallic<sup>6</sup>

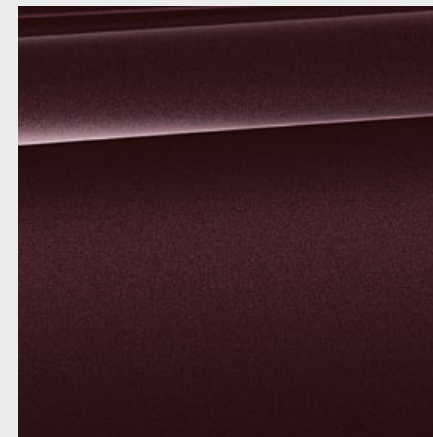

□ **BMW Individual** X1B Ametrine metallic<sup>6</sup>



**Infinite colour diversity.** You want an individual paint finish? BMW Individual is on hand to advise you on your choice.

**[Colour samples]** These colour samples are intended as an initial guide to the colours and materials available for your BMW. However, experience has shown that printed versions of paint, upholstery and interior trim colours cannot in all cases faithfully reproduce the

appearance of the original colour. Please discuss your preferred colour choices with your BMW partner or in your dealership. There you can also see original samples and be assisted with special requests.

<sup>1</sup> Not available for M50d.

<sup>2</sup> Standard for M Sport package and M50d.

<sup>3</sup> Only available for M50d or in conjunction with additional equipment.

<sup>4</sup> Only available for M50d or in conjunction with the M Sport package.

<sup>5</sup> Also optionally available for the M Sport package.

<sup>6</sup> Available from 04/2019.



# INTERIOR COLOURS.

Discover more with the new BMW catalogue app. Now available for your smartphone and tablet.

■ Standard equipment □ Optional equipment

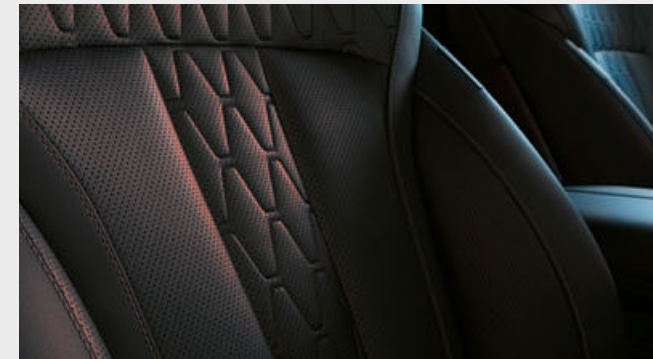

## LEATHER

Available with

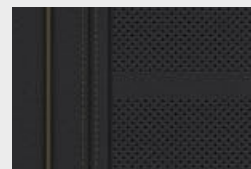

- Base
- xLine
- M Sport package

**Leather Vernasca MCSW** design-perforated Black, interior colour Black

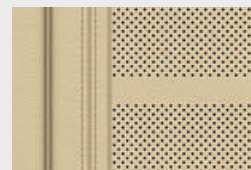

- Base
- xLine
- M Sport package

**Leather Vernasca MCHE** design-perforated Canberra Beige, interior colour Mocha<sup>1</sup>

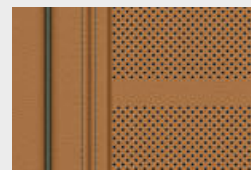

- Base
- xLine
- M Sport package

**Leather Vernasca MCRl** design-perforated Cognac, interior colour Black

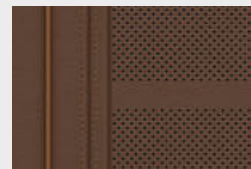

- Base
- xLine
- M Sport package

**Leather Vernasca MCHF** design-perforated Coffee, interior colour Black



- Base
- xLine
- M Sport package

**Leather Vernasca MCEW** design-perforated Ivory White, interior colour Black<sup>2</sup>



- M Sport package

**Leather Vernasca MAH9** Black, contrast stitching Brown, interior colour Black<sup>4</sup>

## INTERIOR TRIM

Available with



- Base
- xLine
- M Sport package

4KM Interior trim finishers Aluminium „Mesh effect“ dark



- Base
- xLine
- M Sport package

4KP Fine-wood trim Ash Grain brown metallic high-gloss

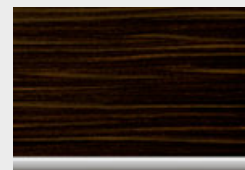

- Base
- xLine
- M Sport package

4KR Fine-wood trim Finesline Stripe brown high-gloss

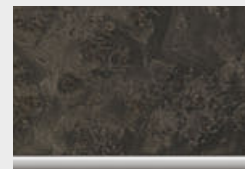

- Base
- xLine
- M Sport package

4KT Fine-wood trim poplar grain light anthracite-brown open-pored



- M Sport package

4KK Interior trim finishers Aluminium Tetragon<sup>4</sup>

## BMW INDIVIDUAL LEATHER

Available with



- Base
- xLine
- M Sport package

**BMW Individual extended leather trim Merino VASW** Black, interior colour Black<sup>2</sup>



- Base
- xLine
- M Sport package

**BMW Individual extended leather trim Merino VATQ** Tartufo, interior colour Black<sup>2</sup>



- Base
- xLine
- M Sport package

**BMW Individual extended leather trim Merino VAHF** Coffee, interior colour Black<sup>2</sup>



- Base
- xLine
- M Sport package

**BMW Individual extended leather trim Merino VAEW** Ivory White, interior colour Black<sup>2</sup>



**Upholstery without frontiers. FANCY A MONOGRAM?** BMW Individual is on hand to advise you on your choice.

## BMW INDIVIDUAL INTERIOR TRIM FINISHERS



- Base
- xLine
- M Sport package

4ML BMW Individual interior trim finishers piano finish Black



- Base
- xLine
- M Sport package

4WW BMW Individual fine-wood trim Ash Grain Silver Grey high-gloss

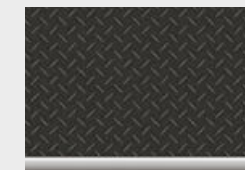

- Base
- xLine
- M Sport package

XET BMW Individual fine-wood trim Finesline Black with Aluminium inserts<sup>5</sup>



**The finest trims.** Light grey fine-wood trim or black finish? BMW Individual is on hand to advise you on your choice.

Please note that even normal long- or short-term use can lead to unrecoverable upholstery damage. This can be caused in particular by non-colourfast clothing.

<sup>1</sup> Only available in conjunction with additional equipment.

<sup>2</sup> Only available in conjunction with comfort seats.

<sup>3</sup> Expected to be available from 12/2018.

<sup>4</sup> Standard for M50d.

<sup>5</sup> Available from 04/2019.



# WHEELS AND TYRES.

Discover more with the new BMW catalogue app. Now available for your smartphone and tablet.



□ 19" light alloy wheels V-spoke style 734, Reflex Silver with run-flat tyres, wheel size 9J x 19 with 265/50 R19 tyres.<sup>1</sup>



□ 20" light alloy wheels Star-spoke style 736 Ferric Grey with mixed tyres and runflat tyres, front 9J x 20 with 275/45 R20 tyres, rear 10.5J x 20 with 305/40 R20 tyres.<sup>1</sup>



□ 20" light alloy wheels V-spoke style 738 in Bicolour with mixed tyres and runflat properties, burnished, front 9J x 20 with 275/45 R20 tyres, rear 10.5J x 20 with 305/40 R20 tyres.<sup>2</sup>



□ 21" light alloy wheels Y-spoke style 744 Bicolour Orbit Grey with mixed tyres and runflat tyres, burnished, front 9.5J x 21 with 275/40 R21 tyres, rear 10.5J x 21 with 315/35 R21 tyres.<sup>1</sup>



□ 21" light alloy wheels Y-spoke style 744 Orbit Grey with mixed tyres and runflat tyres, front 9.5J x 21 with 275/40 R21 tyres, rear 10.5J x 21 with 315/35 R21 tyres.<sup>1</sup>



□ 22" M light alloy wheels V-spoke style 747 M Cerium Grey matt with mixed tyres, burnished, front 9.5J x 22 with 275/35 R22 tyres, rear 10.5J x 22 with 315/30 R22 tyres.<sup>3</sup>

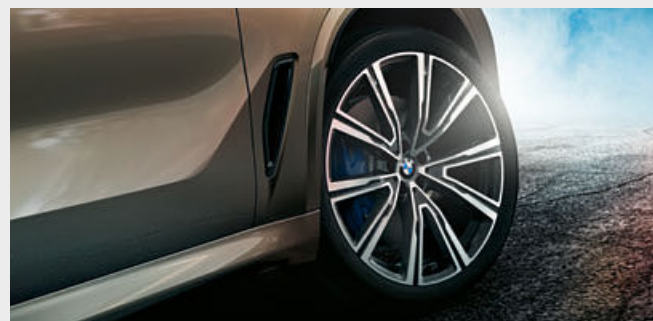

□ 22" BMW Individual light alloy wheels V-spoke style 746 I Orbit Grey with mixed tyres, burnished, front 9.5J x 22 with 275/35 R22 tyres, rear 10.5J x 22 with 315/30 R22 tyres.

# ORIGINAL BMW ACCESSORIES.

Equipment 40 | 41

■ Standard equipment □ Optional equipment ○ Accessories



○ This contemporary **roof box** in Black with titanium silver side trims has a 520-litre capacity and fits all BMW roof rack systems. It can be opened from both sides and features triple central locking on each side which makes it easy to load and provides anti-theft locking.



○ The **BMW Advanced Car Eye 2.0** is a highly sensitive full-HD camera that captures events in front of and behind the car, even when it is parked. In the event of disturbances and extraordinary movement outside the vehicle, the camera automatically records the situation in order to document possible accidents or (attempted) break-ins.



○ The **BMW Pro 2.0 rear bicycle rack** is lightweight yet sturdy and can carry up to 60 kg. Exceptionally easy to use, it carries two bicycles or e-bikes (can be extended to accommodate three bicycles). Its tilt function also allows easy access to the luggage compartment at all times.



○ Anti-slip, water-resistant mat for protecting the luggage compartment from dirt and moisture. In black with stainless steel inlay matching the interior.

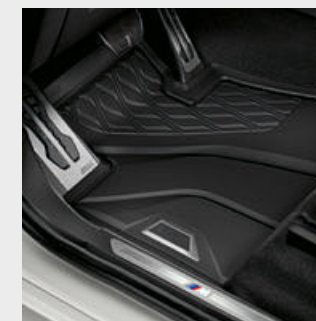

○ Precisely fitting protection against moisture and dirt in the front footwell. Featuring a black design with a stainless steel inlay, they perfectly complement the interior.

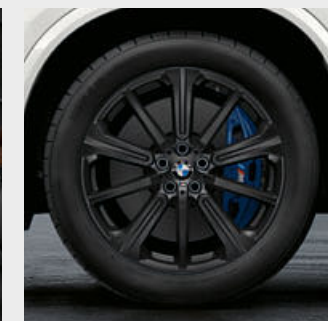

○ High-quality 20" M light alloy wheels Star-spoke style 748 M in Jet Black matt. TPMS summer complete wheel set<sup>4</sup> with run-flat mixed tyres.



○ Weight-optimised 22" M Performance light alloy wheels Star-spoke style 749 M in Bicolor Jet Black, gloss-lathed. TPMS summer complete wheel set

<sup>1</sup> Not available for M50d.  
<sup>2</sup> Only available in conjunction with xLine.  
<sup>3</sup> Only available for M50d.

<sup>4</sup> Also available as a complete winter wheel.

Discover the wide range of innovative solutions available for the exterior and interior, communication & information, and for transportation & the luggage compartment. Your BMW Partner is on hand to advise you on the whole range of Original BMW Accessories

and can also provide you with a special accessories catalogue. For further information, please visit [www.bmw.com/accessories](http://www.bmw.com/accessories)



BMW X5		xDrive40i <sup>6</sup>	xDrive30d	M50d
<b>Weight</b>				
Unladen weight EU (xDrive) <sup>1</sup>	kg	2135	2185	2350
Max. permissible weight (xDrive)	kg	2800	2860	3010
Permitted trailer load, unbraked (xDrive) <sup>2</sup>	kg	750	750	750
Permitted trailer load, braked, max. 12% gradient/ max. 8% gradient (xDrive) <sup>2</sup>	kg	3500/3500	3500/3500	3500/3500
Luggage compartment capacity	l	650–1870	650–1870	650–1870
<b>Engine</b>				
Cylinders/valves		6/4	6/4	6/4
Capacity	cc	2998	2993	2993
Rated output/rated engine speed	kW (hp)/rpm	250 (340)/ 5500–6500	195 (265)/ 4000	294 (400)/ 4400
Max. torque/engine speed	Nm/rpm	450/ 1500–5200	620/ 2000–2500	760/ 2000–3000
<b>Power transmission</b>				
Type of drive		All-wheel	All-wheel	All-wheel
Standard transmission (xDrive)		Steptronic transmission	Steptronic transmission	Steptronic Sport transmission
<b>Performance</b>				
Top speed (xDrive)	km/h	243	230	250 <sup>3</sup>
Acceleration (xDrive) 0–100 km/h	s	5.5	6.5	5.2
<b>Fuel consumption<sup>4, 5, 6</sup> – All engines conform to the EU6 standard</b>				
Urban (xDrive)	l/100 km	10.4–10.6	7.5–6.8	7.6–8.1
Extra-urban (xDrive)	l/100 km	7.4–7.5	5.6–6.2	6.3–6.7
Combined (xDrive)	l/100 km	8.5–8.7	6.0–6.7	6.8–7.2
Exhaust emissions standard (type-certified)		EU6d-temp	EU6d-temp	EU6d-temp
CO <sub>2</sub> emissions, combined (xDrive)	g/km	193–197	158–175	179–189
Tank capacity, approx.	l	83	80	80
<b>Wheels/tyres</b>				
Tyre dimensions		255/55 R18 W	255/55 R18 W	275/40 R21 Y 315/35 R21 Y
Wheel dimensions		8.5J x 18	8.5J x 18	9.5J x 21/ 10.5 J x 21
Material		Light alloy	Light alloy	Light alloy

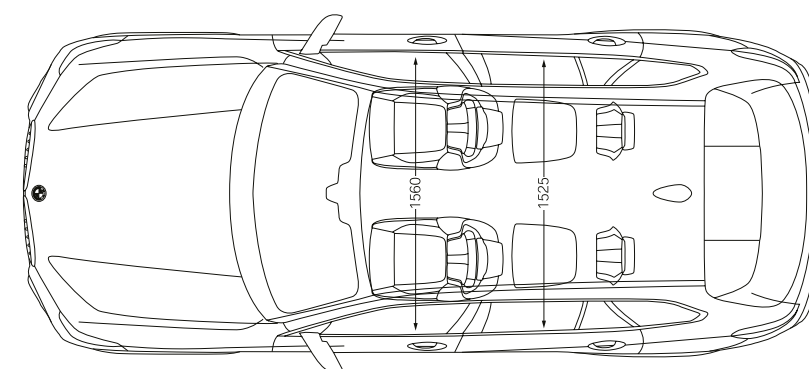
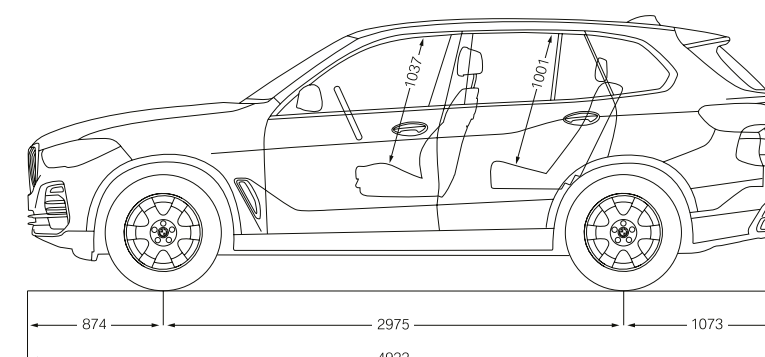
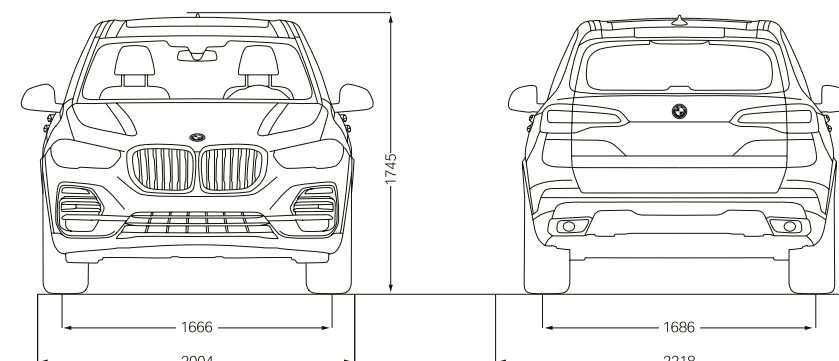

All dimensions in the technical drawing are given in millimetres. Height without roof aerial is 1466 mm. Front track width of the BMW X5 M50d: 1684 mm, rear: 1689 mm. The figures for performance, fuel consumption and CO<sub>2</sub> emissions refer to vehicles with standard transmission.

<sup>1</sup> The EC unladen weight refers to a vehicle with standard equipment and does not include any optional extras. The unladen weight includes a 90% full tank and a driver weight of 75 kg. Optional equipment may affect the weight of the vehicle, the payload and the top speed if the selected equipment has an impact on the vehicle's aerodynamics.

<sup>2</sup> The actual total weight of the trailer must not exceed the maximum trailer load, taking into account the maximum tow bar download.

<sup>3</sup> Electronically limited.

<sup>4</sup> Performance data of petrol engines apply to vehicles using RON 98 fuel. Fuel consumption data apply to vehicles using reference fuels in accordance with EU Regulation 2007/715. Unleaded RON 91 and higher with a maximum ethanol content of 10% (E10) may also be used. BMW recommends RON 95 super unleaded petrol.

<sup>5</sup> The data for fuel consumption, CO<sub>2</sub> emissions and energy consumption are determined in accordance with the measurements processes as defined by European Regulation (EU) 2007/715 in the applicable version. Data refer to a vehicle with base-level equipment in Germany, and the ranges account for differences according to the selected wheel and tyre size and the optional equipment and may change during the configuration process. Figures have been determined on the basis of the new WLTP test cycle and have been converted back into NEDC figures for comparability.

<sup>6</sup> Expected to be available from 12/2018.



**BMW X5 xDRIVE40i WITH M SPORT PACKAGE:**

BMW TwinPower Turbo 6-cylinder petrol engine, 250 kW (340 hp), 22" M light alloy wheels Double-spoke style 742 M Bicolour with mixed tyres, exterior colour in Mineral White metallic, comfort seats in BMW Individual extended leather trim 'Merino' Coffee, interior trim finishers in fine-wood trim 'Fineline Stripe' brown high-gloss.

The models illustrated in this brochure show the equipment and configuration options (standard and optional) for vehicles produced by BMW AG for the German market. Alterations in standard and optional equipment and the configurations available for the different models, as described in this brochure, may occur after 05/16/2018, the date when this brochure went to press, or according to the specific requirements of other markets. Your local BMW Partner is available to provide further details. Subject to change in design and equipment.

© BMW AG, Munich, Germany. Not to be reproduced wholly or in part without prior written permission of BMW AG, Munich.

411 005 136 20 1 2018 BC. Printed in Germany 2018.

