



Sheer
Driving Pleasure



THE BMW 5 SERIES SALOON

BMW EFFICIENT DYNAMICS.
LESS EMISSIONS. MORE DRIVING PLEASURE.



THE BMW 5 SERIES SALOON.

INNOVATION AND TECHNOLOGY.

- 18 BMW EfficientDynamics
- 20 BMW Personal CoPilot/
BMW ConnectedDrive
- 22 Suspension and safety



EQUIPMENT.

- 24 Models and lines
- 30 BMW Individual
- 32 Equipment highlights
- 36 Exterior colours
- 38 Interior colours
- 40 Wheels and tyres
- 41 Original BMW Accessories
- 42 Technical data



DIGITAL DISCOVERY: THE NEW BMW BROCHURES APP.

More information, more driving pleasure: The new BMW brochures app offers you a brand new digital and interactive BMW experience. Download the BMW brochures app for your smartphone or tablet now and explore new perspectives of your BMW.





「 FORWARD THINKING. 」

BUSINESS ATHLETE.

」

」

ADVANCED VISIBILITY. ADVANCED TECHNOLOGY.

MORE SAFETY THANKS TO ADAPTIVE LED-HEADLIGHTS* II IMPROVED
AERODYNAMICS THANKS TO ACTIVE STREAM KIDNEY GRILLE AND
AIR CURTAIN II MORE FORWARD MOMENTUM THANKS TO PRECISE
SHAPES AND LINES

* Available as optional equipment.



DYNAMICS THAT CANNOT GO UNNOTICED.

DYNAMIC M SPORT PACKAGE* II LARGE AIR BREATHERS II
ATHLETIC APRON II 20" GLOSS-LATHED V-SPOKE*

* Available as optional equipment.





THE FOCUS IS FRONT LEFT.

DRIVER-ORIENTED COCKPIT II M LEATHER STEERING WHEEL II 8-SPEED STEPTRONIC SPORT TRANSMISSION II ADAPTIVE MODE DRIVING EXPERIENCE CONTROL II PREMIUM MATERIALS, PRECISION WORKMANSHIP

Some ConnectedDrive Services may differ between countries. Please consult your local BMW partner for more information.



FOLLOWS YOUR MOVEMENTS.

NEW AND INTUITIVE USER TECHNOLOGIES: THE INTELLIGENT BMW GESTURE CONTROL* II THE INNOVATIVE TOUCH DISPLAY* II THE INTELLIGENT VOICE CONTROL SYSTEM*

* Available as optional equipment.





ENERGY PACK. ¹

BMW 530e iPERFORMANCE WITH INTERNAL COMBUSTION ENGINE AND ELECTRIC MOTOR || ENGINE OUTPUT/TORQUE OF 135 KW/290 NM || ELECTRIC OUTPUT/TORQUE OF 83 KW/250 NM || CO₂ EMISSIONS OF 47-52 G/KM || RANGE OF UP TO 48 KM IN PURELY ELECTRIC MODE



Further information on fuel consumption and CO₂ emissions can be found in technical data or consult your BMW partner.



AND THAT'S JUST THE START.

DISCOVER DRIVING PLEASURE THAT NEVER ENDS: THE ONE-OFF CONSTELLATION OF ELEGANT AND DYNAMIC DESIGN, INTELLIGENT BMW TECHNOLOGIES AND INNOVATIVE OPERATING CONCEPTS ALLOWS YOU TO ENJOY EVERY SECOND WHILST ENSURING YOU NEVER LOSE SIGHT OF THE WAY FORWARDS. THE BEST DRIVES FOR THE BEST DRIVERS: THE BMW 5 SERIES UNITES OUTSTANDING OUTPUT WITH POWERFUL ATHLETICISM AND REACHES EVERY DESTINATION WITH THE UTMOST EFFICIENCY AND ASSERTION. A GENUINE BUSINESS ATHLETE:

THE BMW 5 SERIES SALOON.

www.bmw.com/efficientdynamics

MORE POWER FROM LESS FUEL.

More power from 3 to 12 cylinders. Consume less, experience more – the **BMW TwinPower Turbo engines** offer the greatest possible dynamic performance with the greatest possible efficiency thanks to the newest injection systems, variable output control and sophisticated turbocharger technology. Whether diesel or petrol, and no matter how many cylinders, the engines from the BMW EfficientDynamics engine family allow markedly more agile power delivery and outstanding responsiveness even at low rpms, while being fuel-efficient and low in emissions.

MORE DRIVING PLEASURE, LESS EMISSIONS.

Approximately 33% less CO₂ emissions since 2000: **BMW EfficientDynamics** is a technology package that includes not only the drive, but rather the whole vehicle concept and intelligent energy management. Provided as standard in every BMW, a variety of innovative technologies contribute to continuously improving efficiency. Via engine efficiency measures, electrification, lightweight construction methods and optimised aerodynamics, BMW has managed to reduce the CO₂ emissions of its fleet by 33%.

MORE SPEED, LESS WEIGHT.

Lower weight with intelligent lightweight construction. Special consideration for every last detail – intelligent lightweight construction means that the optimal material is found and implemented for each part of the vehicle. With extremely light high-tech materials such as aluminium and carbon fibre, **BMW EfficientLightweight** is pursuing the goal of minimising vehicle weight. That leads to even more aerodynamic driving characteristics, increased stability, and heightened vehicle safety and comfort.



BMW EFFICIENT LIGHTWEIGHT.

BMW EfficientLightweight stands for intelligent lightweight construction that contributes significantly to increased driving dynamics and efficiency. Weight reduction is the basis for the best driving dynamics and exemplary efficiency. Weight-optimised materials such as high-tensile steel, aluminium and magnesium are utilised when constructing various components.

AERODYNAMICS

With targeted measures focusing on Aerodynamics, BMW has optimised drag coefficient and efficiency as well as interior acoustics. Fuel consumption has also been reduced. The Active air stream kidney grille, the Air Breather, the Air curtain on the front wheels and the Aero wheels¹ are all targeted and detailed measures to further reduce air resistance.

INTELLIGENT START-STOP FUNCTION

The Intelligent Start/Stop function enhances driving comfort with the help of the interaction of the navigation, camera and radar data. It switches the engine off only when an extended standing time is expected and the energy required to start the engine is likely to be lower than that saved when it is shut down.

IN THE BMW 5 SERIES SALOON.



BMW 540i / 540i xDrive

- BMW TwinPower Turbo 6-cylinder petrol engine with 250 kW (340 hp) and 450 Nm torque
- Acceleration 0–100 km/h: [5.1] s / [4.8] s xDrive; top speed: [250]² km/h / [250]² km/h xDrive
- Combined fuel consumption: [7.1–7.4] l/100 km / [7.7–7.9] l/100 km xDrive
- Combined CO₂ emissions: [161–168] g/km / [174–179] g/km xDrive

BMW 530i / 530i xDrive

- BMW TwinPower Turbo 4-cylinder petrol engine with 185 kW (252 hp) and 350 Nm torque
- Acceleration 0–100 km/h: [6.1] s / [6.0] s xDrive; top speed: [250]² km/h / [250]² km/h xDrive
- Combined fuel consumption: [5.8–6.1] l/100 km / [6.2–6.5] l/100 km xDrive
- Combined CO₂ emissions: [132–139] g/km / [142–147] g/km xDrive

BMW 520i

- BMW TwinPower Turbo 4-cylinder petrol engine with 135 kW (184 hp) and 290 Nm torque
- Acceleration 0–100 km/h: [7.8] s; top speed: [235] km/h
- Combined fuel consumption: [5.8–6.0] l/100 km
- Combined CO₂ emissions: [132–137] g/km

BMW 530e with iPerformance

- BMW TwinPower Turbo 6-cylinder petrol engine with 250 kW (340 hp) and 450 Nm torque
- Acceleration 0–100 km/h: [5.1] s / [4.8] s xDrive; top speed: [250]² km/h / [250]² km/h xDrive
- Combined fuel consumption: [7.1–7.4] l/100 km / [7.7–7.9] l/100 km xDrive
- Combined CO₂ emissions: [161–168] g/km / [174–179] g/km xDrive

BMW 530d / 530d xDrive

- BMW TwinPower Turbo 6-cylinder diesel engine with 195 kW (265 hp) and 620 Nm torque
- Acceleration 0–100 km/h: [5.7] s / [5.4] s xDrive; top speed: [250]² km/h / [250]² km/h xDrive
- Combined fuel consumption: [5.0–5.2] l/100 km / [5.3–5.6] l/100 km xDrive
- Combined CO₂ emissions: [131–138] g/km / [141–147] g/km xDrive

BMW 520d / 520d xDrive

- BMW TwinPower Turbo 4-cylinder diesel engine with 140 kW (190 hp) and 400 Nm torque
- Acceleration 0–100 km/h: 7.7 [7.3] s / [7.3] s xDrive; top speed: 238 km/h / [235] km/h xDrive
- Combined fuel consumption: 4.5–4.8 [4.5–4.6] l/100 km / [4.7–4.9] l/100 km xDrive
- Combined CO₂ emissions: 119–127 [117–121] g/km / [124–129] g/km xDrive

BMW M550d xDrive

- BMW TwinPower Turbo 6-cylinder diesel engine with 294 kW (400 hp) and 760 Nm torque
- Acceleration 0–100 km/h: [4.4] s; top speed: [250]² km/h
- Combined fuel consumption: [6.5–6.6] l/100 km
- Combined CO₂ emissions: [171–173] g/km

BMW 518d

- BMW TwinPower Turbo 4-cylinder diesel engine with 110 kW (150 hp) and 350 Nm torque
- Acceleration 0–100 km/h: [8.8] s; top speed: [220] km/h
- Combined fuel consumption: [4.4–4.6] l/100 km
- Combined CO₂ emissions: [116–122] g/km

¹ Available as optional equipment.
² Electronically regulated.

The quoted performance, fuel consumption and CO₂ emissions figures are for vehicles with standard transmission. Figures in [] refer to vehicles with Steptronic transmission.

The data for fuel consumption, CO₂ emissions and energy consumption are determined in accordance with the measurements processes as defined by European Regulation (EU) 2007/715 in the applicable version. Data refer to a vehicle with base-level equipment in Germany, and the ranges account for differences according to the selected wheel and tyre size and the optional equipment and may change during the configuration process.

Figures have been determined on the basis of the new WLTP test cycle and have been converted back into NEDC figures for comparability. [For these vehicles, values other than those specified here may apply for the assessment of taxes and other vehicle-related charges that are (also) based on CO₂ emissions.] For further information on fuel consumption and CO₂ emissions, please see pages 42 | 43 or consult your local BMW partner.

BMW Personal CoPilot. By your side, when you decide.

THE INNOVATIVE BMW ASSISTANCE SYSTEMS.

Enjoy the ultimate in comfort and safety with the BMW Personal CoPilot. Whether it's for driving or parking, you can rely on BMW Personal CoPilot driver assistance systems in every situation. The most cutting-edge systems, such as radar, ultrasound and cameras, dependably register the vehicle's surroundings, forming the basis for intelligent driver assistance systems. Either activated when desired, or as emergency assistance in the background – BMW Personal CoPilot assistance systems make every journey in your BMW even safer and more enjoyable.

CLOSER TO AUTONOMOUS DRIVING THAN EVER BEFORE.

Autonomous driving is not a utopia, it is the future: All over the world, BMW Personal CoPilot test vehicles are already driving completely independently without the driver's intervention and not only show impressively how mobility will change in the near future – they also offer an outlook on the next level of driving pleasure. Even today, BMW Personal CoPilot already offers a large number of intelligent semi-automated assistants that actively support and relieve the driver in almost every driving situation.

SIMPLY PARK IT.

Intelligent parking assistance systems from BMW Personal CoPilot are available so that you don't just look forward to every ride in your BMW, but also to parking. For example, the Parking assistant already displays suitable parking spaces as you drive past and, depending on the BMW model, runs the parking process either partially or completely independently. But here too, automation will continue to advance, so that in the future it will be possible for vehicles without drivers to search for a parking space and execute the parking process autonomously.

REMOTE CONTROL PARKING.

The Remote Control Parking^{1,3} function allows the driver to conveniently get out of the vehicle before parking it via remote control by moving it forward into, or reversing out of, a tight parking space or garage. The Remote Control Parking function is activated by the driver once outside the car, with the BMW display key.

DRIVING ASSISTANT PLUS.

Driving Assistant Plus^{1,2} offers automatic driving with greater comfort and security in monotonous and dangerous situations. These can include on the one hand traffic jams, slow-moving traffic or long journeys through the city, on country roads or motorways and on the other hand navigating junctions and hazardous lane changes. The vehicle takes action when the driver either cannot or will not.

ACTIVE CRUISE CONTROL WITH STOP&GO FUNCTION.

Active cruise control with Stop&Go function¹, Speed Limit Info including No-overtaking indicator⁴ and Approach control warning with braking function reacts to stationary vehicles, independently maintains a preselected distance from the vehicle ahead and controls speed down to standstill, automatically accelerating again as soon as traffic flow allows it.

IN THE BMW 5 SERIES SALOON.

The key visual for BMW Personal CoPilot shown here is an exemplary, artistic representation, which can deviate from the design and equipment of the BMW model described in this medium.

BMW ConnectedDrive Connected to be free.

Innovation and Technology 20 | 21

CONNECTED FOR OVER 40 YEARS.

Focused on the future – from the very beginning. By the 1970s, BMW had already made headway in connected mobility. Another milestone of the digital future was surpassed in 1999: vehicles with built-in SIM cards. Then came the first online functionality, Google Services and innovative display systems such as the BMW Head-Up Display. Throughout this process, the desires of the customer have always taken centre stage. In a first for a premium automobile manufacturer, BMW makes it possible to book and pay for services flexibly via the BMW ConnectedDrive Store, in the vehicle or on a computer at home. And with the introduction of BMW Connected and the Open Mobility Cloud, BMW is taking the next steps into the future of mobility.

MORE THAN 20 SERVICES IN THE BMW CONNECTED DRIVE STORE.

ConnectedDrive Services open the gate to the digital world of BMW. Use vehicle apps such as news, weather, office or online search on the go and be well informed at all times. ConnectedDrive Services form the basis to order further digital services such as Concierge Services or Online Entertainment from the ConnectedDrive Store – always, everywhere, simply and flexibly.

IN TOUCH 24/7 WITH BMW CONNECTED.

Are the doors of my car really locked, when should I leave my office to arrive in time for dinner at the fancy Italian restaurant and how will I find my way there? As your personal mobility assistant, the BMW Connected App can easily help you with all these questions. It connects you directly with your car, giving you access before and during your trip to numerous functions, which make every drive simpler and more comfortable.

BMW CONNECTED.

BMW Connected^{1,6} is a personal mobility assistant which facilitates everyday mobility and assists drivers in reaching their destinations relaxed and on time. Mobility-relevant information such as recommendations for optimal departure times are available remotely via smartphone or smart watch and can be seamlessly transferred into the car.

REMOTE 3D VIEW.

With Remote 3D View^{1,5}, the user can see the parked vehicle's surroundings on a smartphone. The function can be activated via the BMW Connected App (for iOS). It allows the user to observe the area around the vehicle from a distance as a 3D image.

REMOTE SERVICES.

With the Remote Services⁶ of the BMW Connected App, various functions of the vehicle, such as locking or unlocking the car, can be operated remotely. To use this feature, customers simply need to activate Remote Services once in the BMW ConnectedDrive customer portal at www.bmw-connecteddrive.com.

IN THE BMW 5 SERIES SALOON.

¹ Available as optional equipment.

² Only available in conjunction with Steptronic transmission.

³ Only available in conjunction with additional equipment.

⁴ Only available in conjunction with a navigation system.

⁵ Remote Services and Parking Assistant Plus are required for the use of Remote 3D View.

⁶ Requires BMW ConnectedDrive Services.

Some ConnectedDrive Services may differ between countries. Please consult your local BMW partner for more information.

■ Standard equipment □ Optional equipment



Integral Active Steering^{1, 5} combines support that varies based on the steering angle on the front axle, and rear wheels that also contribute to steering. At lower speeds, it offers greater manoeuvrability and agility by turning the rear wheels opposite the front wheels. Beginning around 60 km/h, the rear wheels turn parallel to the front wheels, to increase driving stability and comfort.

The **8-speed Steptronic Sport transmission** offers incredibly sporty gear changes. Whether automatic or manual using gearshift paddles or gear lever - for comfortable coasting or incredibly dynamic driving. In SPORT mode and with the gear lever in the left-hand S/M position, the gear shifts are configured for maximum performance.

The **adaptive suspension^{1, 4}** makes it possible to adjust the damper characteristics to suit any given driving situation, increasing comfort and driving dynamics. In addition to the standard COMFORT setting for increased driving comfort, the SPORT program offers athletic damper settings.

The **intelligent BMW xDrive all-wheel drive system** smoothly and variably distributes drive power to the front and rear wheels for maximum traction, driving dynamics and safety in every driving situation. For even better agility, the electronically controlled power distribution for instance counterbalances oversteer or understeer on bends.

Adaptive Drive^{1, 6} combines the active body roll stabilisation Dynamic Drive and the Adaptive suspension for regulation of the stabilisers and dampers as required. At the same time this ensures outstanding driving comfort levels with hardly any noticeable body roll, which in turn permits higher speeds and shorter braking distances when taking bends.

M Sport suspension^{1, 5} is lowered by roughly ten millimetres. It also features shorter suspension springs and tighter damper settings, as well as harder stabilisers. Together these result in improved traction and reduced body roll, which in turn allows for an extremely athletic driving style.

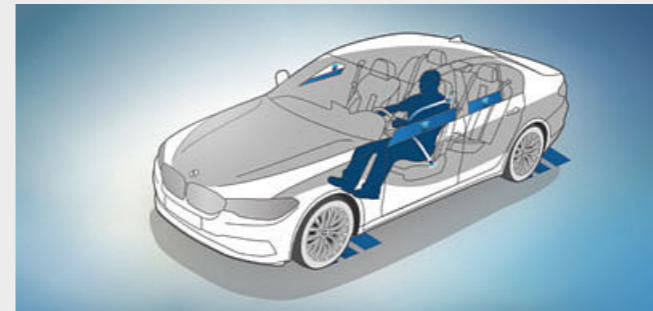

□ **Active Protection** is the BMW ConnectedDrive preventive passenger protection system. Active Protection warns the driver if it detects signs of tiredness, safety belts are pretensioned in critical situations, electric seats are returned to upright positions and the windows and sliding roof are closed. After an accident occurs, the brakes are automatically applied until the vehicle reaches a standstill.



■ The extremely torsionally stiff but light **body construction** provides the basis for sporty driving dynamics, high-precision steering and agility. Additionally, it offers the passengers the best possible all-round protection.



□ **LED headlights with Adaptive headlights**, variable city and motorway light distribution and BMW Selective Beam provide optimum illumination of the road when driving in the dark. Even at a standstill, the integrated cornering lights are automatically activated by signalling or turning the steering wheel and are active at speeds of up to 35 km/h.

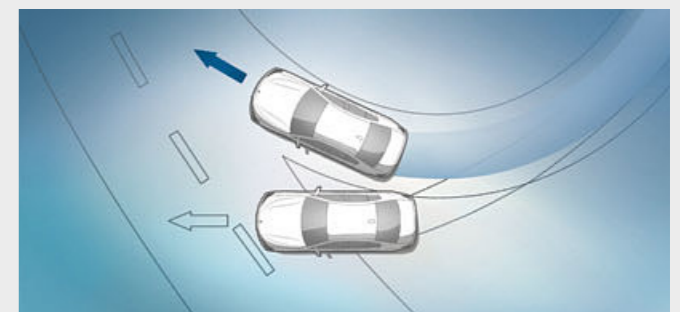

■ **Dynamic Stability Control (DSC)** permanently assesses the vehicle's movements and stabilises it using engine and braking regulation when unstable driving conditions are detected. Additional features of DSC are, for example, brake drying, braking readiness or the Hill-Start assistant, which holds the vehicle briefly in place when starting on inclines to prevent it from rolling backwards.

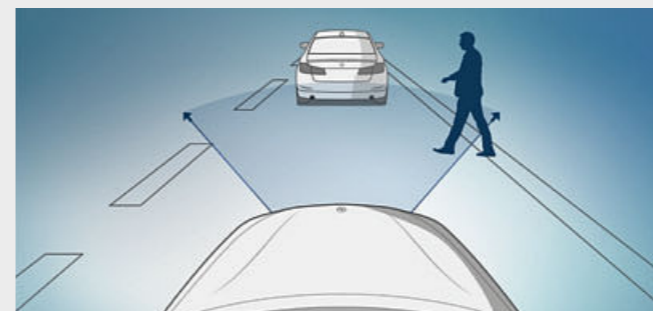

■ **Person warning with light city braking function²** actively assists the driver with the prevention of collisions involving pedestrians. It is active at speeds of up to 60 km/h and preconditions the brakes for increased responsiveness. In the event of an emergency, the system prevents a collision or ensures that the collision speed is reduced considerably.

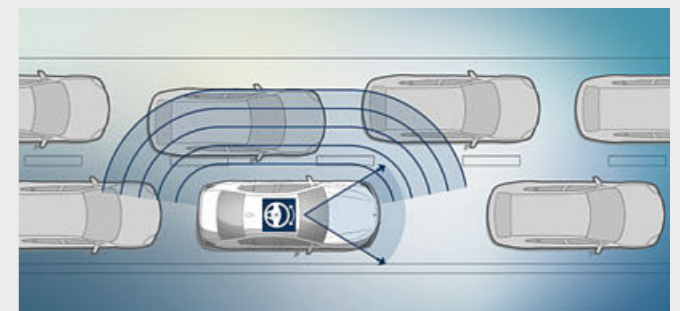

□ The **Lane Departure Warning³** detects lane markings and alerts the driver before an unintentional lane change at speeds above around 70 km/h by means of vibrations in the steering wheel. The warning is not activated if the lane change is deliberate, that is, when the indicator has been activated.

¹ Available as optional equipment.
² Function may be limited in darkness, fog or bright glare.
³ Part of the Driving Assistant or Driving Assistant Plus.
⁴ Not available for BMW M550i.

⁵ Not available for BMW 530e iPerformance.
⁶ Only available for the BMW 540i, 540i xDrive, 530d, 530d xDrive and 540d xDrive.
 Some ConnectedDrive Services may differ between countries. Please consult your local BMW partner for more information.

BASIC.

Discover more with the new BMW catalogue app. Now available for your smartphone and tablet.



■ The free-standing 8.8" control display and the detail design of the centre console in combination with the Oxide Silver dark matte interior trim and Pearl-Gloss Chrome accent line create a unique, driver-oriented cockpit.

□ The leather upholstery in Dakota Cognac gives the interior an elegant and at the same time sporty feel. High-quality materials and outstanding finishing deliver a first-class ambience.

Selected standard model equipment:

- 17" light alloy wheels V-spoke style 618
- LED headlights
- Multifunction leather steering wheel
- Automatic air conditioning with dual zone control
- Radio BMW Professional with 8.8" LCD colour screen
- Driving Experience Control
- Semi-electric seat adjustment for driver and front passenger



■ 17" light alloy wheels V-spoke style 618, wheel size 7.5J x 17, with 225/55 R17 tyres.

LUXURY LINE.

Equipment 24 | 25

■ Standard equipment □ Optional equipment

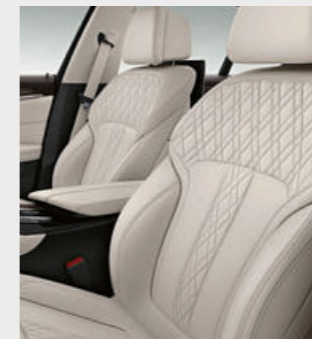

■ The Sport leather steering wheel with a thinner rim and contoured thumb rests is perfectly shaped with an exceptionally pleasant feel.

□ The Comfort seats in exclusive Ivory White Nappa leather with contrast piping highlight the elegant lines of the interior and are adjustable to the ideal ergonomic position.

■ 18" light alloy wheels W-spoke style 632, size 8J x 18 with 245/45 R18 tyres.

□ 19" light alloy wheels Multi-spoke style 633, 8J x 19 with 245/40 R19 tyres.

Luxury Line exterior equipment:

- BMW kidney grille with exclusively designed vertical slats and grille frame in Chrome high-gloss
- Front bumper with specific design elements in Chrome high-gloss
- LED fog lights
- 18" light alloy wheels W-spoke style 632 in Reflex Silver, alternatively
- 19" light alloy wheels Multi-spoke style 633 in Reflex Silver, other wheels available
- Air Breather in Chrome high-gloss
- Side window surrounds in Chrome high-gloss, window guides, window recess finisher, B-pillar, mirror base and mirror foot in Black high-gloss
- Rear bumper with specific horizontal design elements on the rear diffuser in Chrome high-gloss
- Tailpipe trim strip in Chrome high-gloss, on both sides or with free-form

Luxury Line interior equipment:

- Door sill finishers in aluminium, illuminated with "Luxury Line" designation
- Seats in Leather 'Dakota' with line-specific stitching and leather piping; other upholsteries available
- Sport leather steering wheel in Black, alternatively in Dark Coffee²
- Car key with buttons and Chrome detailing in high-gloss
- Instrument panel in Sensatec Black or Dark Coffee, alternatively
- BMW Individual leather Black
- Interior trim finishers in fine-wood trim 'Fineline' Ridge with highlight trim finisher in Pearl Chrome; other trims¹ available
- Variable ambient light in six colours

¹ Available as optional equipment.
² Colour depends on the selected upholstery colour.

SPORT LINE.

Discover more with the new BMW catalogue app. Now available for your smartphone and tablet.



■ The sport leather steering wheel with multifunction buttons¹ creates a sense of dynamics and highlights the sporty character.

□ The interior design with its sport seats and leather upholstery in Dakota Night Blue with exclusive stitching brings the exterior's contemporary dynamics inside.

■ 18" light alloy wheels double-spoke style 634 Orbit Grey gloss-lathed, 8J x 18 with 245/45 R18 tyres.

□ 19" light alloy wheels V-spoke style 635 Ferric Grey gloss-lathed with mixed tyres and run-flat properties, front 8J x 19 with 245/40 R19 tyres, rear 9J x 19 with 275/35 R19 tyres.

Sport Line exterior equipment:

- BMW kidney grille with vertical slats in Black high-gloss and grille frame in Chrome high-gloss
- Front bumper with specific design elements in Black high-gloss
- LED fog lights
- 18" light alloy wheels W-spoke style 634 in Orbit Grey, alternatively
- 19" light alloy wheels Multi-spoke style 635 in Ferric Grey; other wheels available
- Air Breather in Black high-gloss
- Side window surrounds, window guides, window recess finisher, B-pillar, mirror base and mirror foot in Black high-gloss
- Rear bumper with specific horizontal design elements on the rear diffuser in Black high-gloss
- Tailpipe trim in Black Chrome, on both sides or with free-form

Sport Line interior equipment:

- Door sill finishers in aluminium, illuminated with "Sport Line" designation
- Sport seats for driver and front passenger, alternatively
- Comfort seats front, electrically adjustable
- Seats in cloth/leather combination 'Plectoid', alternatively in
- Leather 'Dakota' with line-specific stitching and piping or Exclusive leather, 'Nappa'
- Sport leather steering wheel in Black with Multifunction
- Car key with buttons and high-gloss Chrome detailing
- Instrument panel in Black, alternatively in
- Sensatec Black^{1,3} or Dark Coffee³, or in BMW Individual leather Black
- Interior trim finishers in Black high-gloss with accent in Pearl Chrome; other trims¹ available
- Variable ambient light in six colours

M SPORT PACKAGE.

Equipment 26 | 27

■ Standard equipment □ Optional equipment



■ M Leather steering wheel including multifunction buttons, steering wheel rim in leather 'Walknappa' Black with contoured thumb rests.

□ Featuring leather upholstery in Dakota Black with Blue contrast stitching, the design also creates dynamic highlights in the interior.

■ 18" M light alloy wheels Double-spoke style 662 M in Bicolour Ferric Grey gloss-lathed, with mixed tyres and run-flat properties, front 8J x 18 with 245/45 R18 tyres, rear 9J x 18 with 275/40 R18 tyres.

□ 19" M light alloy wheels Double-spoke style 664 M Orbit Grey, gloss-lathed with run-flat properties and mixed tyres, front 8J x 19 with 245/40 R19 tyres, rear 9J x 19 with 275/35 R19 tyres.

M Sport package exterior equipment:

- M Aerodynamics package with front apron, side skirts and rear apron with diffuser insert in Dark Shadow metallic
- BMW kidney grille with vertical slats in Black high-gloss and grille frame in Chrome high-gloss
- LED fog lights
- 18" M light alloy wheels Double-spoke style 662 M with mixed tyres, other wheels¹ available
- M Sport suspension, lowered for sDrive and xDrive
- M Sport brake² with brake callipers in Dark Blue metallic
- BMW Individual high-gloss Shadow Line
- M designation on the front side panels
- Exterior mirror caps in body colour
- Tailpipe trim in Chrome high-gloss, both sides
- Exclusive paintwork in Carbon Black, other paintworks available

M Sport package interior equipment:

- M door sill finishers, illuminated
- Sport seats for driver and front passenger in Cloth/Alcantara combination in exclusive M look, alternatively in
- Leather 'Dakota'¹ Black with exclusive M look and Blue contrast stitching, other upholsteries available
- M Leather steering wheel with Multifunction
- BMW Individual headliner Anthracite
- Instrument cluster with M specific look in SPORT mode
- Interior trim finishers in Aluminium Rhombicle with accent in Pearl Chrome, other trims¹ available
- Gear lever with M designation
- M driver footrest with M-specific pedal covers
- Car key with exclusive M designation

¹ Available as optional equipment.

² Only available in conjunction with the BMW 530i, 530i xDrive, 540i, 540i xDrive, 530e, 525d, 530d, 530d xDrive and 540d xDrive.

³ Colour depends on chosen upholstery colour.

BMW M.

The BMW M550d xDrive Saloon.



Driving pleasure intensified: M automobiles combine the best with the dynamic genes of BMW M to create a class of their own. An exclusive offer from BMW M GmbH, they embody style with razor-sharp design and impress with the most powerful drivetrains and maximum dynamics. At the same, they also offer high levels of comfort. This trio is also evident in the **BMW M550d xDrive Saloon**. In addition to the features of the M Aerodynamics package, exceptional highlights bring out its athletic nature. The distinctive design of the exterior alone is hugely eye-catching: Exclusive detailing in the signature colour Cerium Grey, optional 20" M light alloy wheels Double-spoke style 668 M and double tailpipe trims in Black Chrome on both sides add sporty touches. The vehicle is driven by the most powerful petrol and diesel engine in the BMW 5 Series, with sporty characteristics that were specifically designed for M and that offer an emotional sound, making the power audible. The optional Adaptive M suspension Professional guarantees the ultimate in driving dynamics while keeping comfort levels at a max. The rear-wheel oriented BMW xDrive gives this a further boost. Direct steering delivers a driving experience shaped by even greater precision. While the powerful M Sport brake ensures a secure standstill over the shortest possible distance.



BMW iPERFORMANCE.

The BMW 530e plug-in hybrid.



As a plug-in hybrid, the **BMW 530e iPerformance Saloon** combines a 135 kW (184 hp) BMW TwinPower Turbo 4-cylinder petrol engine with a 70 kW (95 hp) electric motor. The system has an output of 185 kW (252 hp). Intelligent energy management coordinates all of the conventional BMW drive components with the efficient drive technology of BMW eDrive. The electric motor can power the vehicle independently or support the engine, depending on the required power output and current battery level. During coasting and braking, the motor even transforms kinetic energy into electric energy, which is stored in the lithium-ion high-voltage battery for use by the electric drive system. Running purely on electricity, the vehicle has a range of up to 45 km and a maximum speed of 140 km/h. The combined fuel consumption is [1.9–2.1] l/100 km with CO₂ emissions of [44–49] g/km. The vehicle can be recharged at home from any domestic power socket using the standard charging cable included, or even more conveniently with a BMW i Wallbox. With the innovative Digital Charging Service, the vehicle can automatically be charged during the most cost-efficient time slot or even with self-generated solar energy. When on the move, the BMW 530e iPerformance Saloon can be recharged at public charging stations.



19" M light alloy wheels
Double-spoke style
664 M Cerium Grey,
gloss-lathed with mixed
tyres, front 8J x 19 with
245/40 R19 tyres, rear
9J x 19 with 275/35 R19
tyres.



The interior design is
equally uncompromising:
Exclusive Nappa leather
in Mocha with exclusive
stitching¹ and piping in
contrast, an interior trim
in Aluminium Rhombicle
and the dashboard in
Sensatec² Black all create
an atmosphere that
expresses pure athleticism
and power.

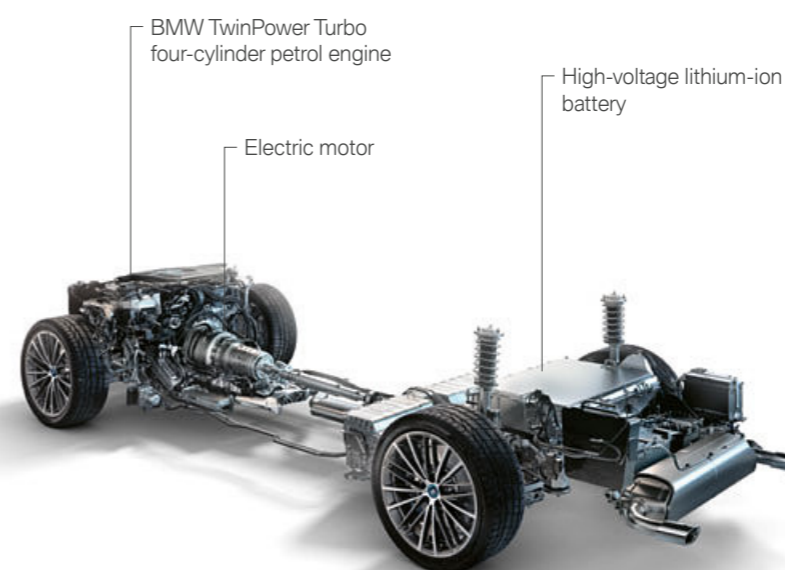

The car's battery is easy to charge on the go at public charging stations using a rapid-charge cable² available from BMW accessories.



The iPerformance model is distinguished by an eDrive badge on the C-pillars, an i badge on the front side panels and model designation at the rear.

¹ Available as optional equipment.

² Mode 2-cable for household sockets comes as standard equipment.



BMW Individual paint finish Rhodonite Silver metallic in sporty elegance with the 20" BMW Individual light alloy wheels V-spoke style 759 I.

BMW Individual doorsill finishers with illuminated lettering.



BMW INDIVIDUAL.

The expression of personality.

The BMW 5 Series. Inspired by BMW Individual.

To ensure that all your wishes come true, the BMW Individual collection offers a virtually inexhaustible range of equipment options for the BMW 5 Series Saloon. Each and every facet is exceptional in its flawless workmanship and premium quality materials. BMW Individual Manufaktur fulfils even more individual and unusual requests, including unique hand-made details.

Special equipment from BMW Individual artfully emphasizes the athletic, elegant character of the BMW 5 Series Saloon. The optional BMW Individual Rhodonite Silver metallic paint with special pigmentation creates eye-catching contrasts. In combination with the 20" light alloy wheels, the exterior also clearly demonstrates that the exclusive BMW Individual equipment embodies perfection down to the last detail. Only leather of the utmost quality is used for the BMW Individual full leather trim Merino in Caramel. Further highlights include interior trim finishers in Plum Brown high-gloss and the leather steering wheel with inlays exclusively in Piano Finish Black.



BMW Individual full leather trim Merino in Caramel with weave-effect stitching, hand-applied piping and contrast seams.

BMW Individual full leather¹ trim Merino in Caramel as well as trims in Damson Brown high-gloss and additional equipment details by BMW Individual.¹



EXPERIENCE BMW INDIVIDUAL INTERACTIVE.
WITH THE BMW INDIVIDUAL APP FOR iOS AND ANDROID.

¹ Includes instrument panel in leather, top surface in Black Nappa leather with contrast stitching and underside in fine-grain Merino leather to match the upholstery colour.

EQUIPMENT HIGHLIGHTS.

Discover more with the new BMW catalogue app. Now available for your smartphone and tablet.

■ Standard equipment □ Optional equipment



□ The Adaptive LED headlights include BMW Selective Beam, cornering lights and adaptive headlights. The light colour is similar to daylight and provides an ideal, even illumination of the road to improve visibility and make driving in the dark less tiring. The iconic light design with four light elements makes the vehicle recognisable as a BMW even at night.



□ The Glass roof with slide and lift function, including an electric sliding interior roof, anti-trap protection, as well as comfort opening and closing, allows the airflow to be individually regulated to create a pleasant interior climate. The integrated wind deflector prevents draughts from developing in the interior and ensures a lower level of wind noise.



□ The M seat belts with belt tensioner and belt force limiter boast an exquisite woven highlight in the classic M colours.



□ Automatic tailgate operation allows the convenient opening and closing of the tailgate by simply pressing the conveniently located button in the door panelling or on the car key. The tailgate can also be opened in the conventional manner, using the outside handle, and closed using a button on the inside of the tailgate.

□ The Comfort access system makes it possible to open all four vehicle doors without using the key. This equipment option includes contactless opening and closing of the tailgate with a quick wave of the foot under the rear bumper.¹

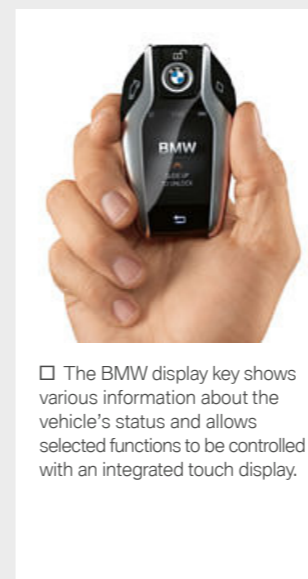

□ The BMW display key shows various information about the vehicle's status and allows selected functions to be controlled with an integrated touch display.



□ The Soft-Close function pulls the slightly-open door shut automatically and nearly silently.



□ If the indicator is on, the radar-based Lane Change Warning² warns the driver to approaching vehicles in the blind spot as well as vehicles in the neighbouring lane. The system functions beginning at speeds of 20 km/h, and in dangerous situations, it causes the steering wheel to vibrate and the triangle symbol in the exterior mirror to blink.



■ The Air Breather channels air to the front wheels, reducing air resistance, fuel consumption and CO₂ emissions.



□ The trailer tow hitch with electrically adjustable tow ball is approved for heavy loads of up to 2,000 kg. In order to stabilise things, trailer stability control automatically brakes the pulling vehicle if the trailer begins to swing. The electrically adjustable tow ball is not visible when stowed under the rear apron.



□ BMW Individual Exterior Line in satinised Aluminium creates luxurious highlights with window recess finishers and side frame trim strips in silky matt brushed Aluminium. The exterior mirror frames and bases in Black high-gloss create a stylish contrast to these elements.



□ The M Sport brake³ with multi-piston brake calipers in dark blue and M designation features exceptional braking performance. Adapted to the vehicle's extremely high dynamic potential, it also allows for a pronouncedly more athletic driving style and excellent braking on wet surfaces.

¹ Contactless opening and closing of the tailgate only available in conjunction with automatic tailgate operation.

² Function is part of Driving Assistant and Driving Assistant Plus.

³ Included in the M Sport package for the BMW 530i, 530i xDrive, 540i, 540i xDrive, 530e iPerformance, 525d, 530d. Optionally available for the BMW 540i, 540i xDrive and 540d.

EQUIPMENT HIGHLIGHTS.

Discover more with the new BMW catalogue app. Now available for your smartphone and tablet.

■ Standard equipment □ Optional equipment



□ With BMW Gesture Control¹, certain functions can be operated by means of defined hand movements. For certain operations the system will for example recognise gestures such as 'swiping' or 'pointing' for accepting or rejecting an incoming call, or circular motions of the index finger to adjust volume.



□ The Automatic air conditioning with 4-zone control comes with the equipment included in Automatic air conditioning with 2-zone control with extended features, along with two air vents in the B columns. Additionally, the rear passengers can individually adjust their own climate via a separate control element with display.



□ Ambient light creates a relaxed lighting atmosphere, including ambient light accents and the welcome light.



□ The comfort seats for driver and front passenger can be electrically adjusted in a variety of ways and provide a perfect seating position for a relaxed arrival.

□ The Lumbar support for the driver and front passenger seats can be adjusted both vertically and laterally, allowing for an orthopaedically optimised seating position.



□ The Bowers & Wilkins Diamond surround sound system¹ with two diamond tweeters features outstanding studio-quality sound for every seat in the car. 16 carefully positioned speakers ensure a mesmerising sound experience. The speakers are illuminated, visually emphasizing the system's outstanding sound quality.



□ The Ambient Air Package⁷ comprises a fragrance dispersal function and an air ionisation function.



□ Telephony with wireless charging² offers a comprehensive telephony package with Bluetooth connectivity and the technical capacity for a WiFi hotspot.



□ In warm weather, the Active seat ventilation front³, provides a cool and pleasant seat temperature, resulting in a more comfortable driving experience.



□ The full-colour BMW Head-Up Display⁴ projects all information relevant to the journey directly into the driver's field of vision.

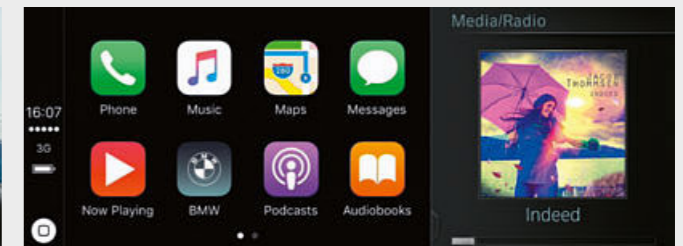

□ Preparation for Apple CarPlay^{5,7} supports the convenient and wireless use of a selected iPhone[®] functions in the vehicle. This allows smartphone content, along with functions such as music, iMessages/text messages, telephony, Siri and selected third-party apps to be displayed and operated via the vehicle's user interface and via voice control.



□ BMW Night Vision¹ with person recognition makes people and large animals visible on the Control Display from a distance using heat imaging and illuminates them with the Dynamic Marker Light in the main headlight. An additional warning system is also automatically activated when the vehicle is started, regardless of the status of the imaging display.



□ Driving Assistant Plus⁶ offers automatic driving with greater comfort and security in monotonous and dangerous situations. These can include on the one hand traffic jams, slow-moving traffic or long journeys through the city, on country roads or motorways and on the other hand navigating junctions and hazardous lane changes. The vehicle takes action when the driver either cannot or will not.



□ The equipment package Parking Assistant Plus⁷ makes parking and manoeuvring the vehicle easier. It features Surround View including Top View, Remote 3D View, PDC and the Parking Assistant with linear guidance, which parks the vehicle parallel or perpendicular to the lane completely automatically. The system works by measuring potential spaces while driving past them at a low speed.

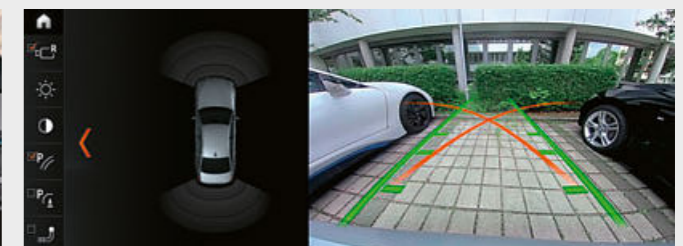

□ The Rear view camera⁷ enables improved orientation when reversing at speeds below 15 km/h, for example when parking. It shows the area behind the car on the Control Display. Interactive track lines for measuring distance and turning circles assist the driver when manoeuvring, obstacles are marked in colour.

¹ Only available in conjunction with the Professional Navigation system.
² Supports inductive charging for Qi-compatible mobile phones. Special charging cases are available from Original BMW Accessories for selected smartphones that do not support the Qi standard for inductive charging. The WiFi hotspot fulfils all in-vehicle requirements for use of the internet with the maximum LTE standard. Usage is subject to cost.

³ Only in conjunction with comfort seats in the front.
⁴ The information in the BMW Head-Up Display is not fully visible when viewed through polarised sunglasses. Content shown will depend on the equipment options chosen. Further optional equipment is required to display specific items.

⁵ Apple CarPlay[®] compatibility and supported functions depend on the model year and the software installed on the iPhone[®]. When the Apple CarPlay[®] preparation is in use, selected vehicle data is transferred to the phone. The mobile phone manufacturer is responsible for any further processing of the data.
⁶ Only available in conjunction with Steptronic transmission.

⁷ Only available in conjunction with additional equipment.

EXTERIOR COLOURS.

Discover more with the new BMW catalogue app. Now available for your smartphone and tablet.

■ Standard equipment □ Optional equipment

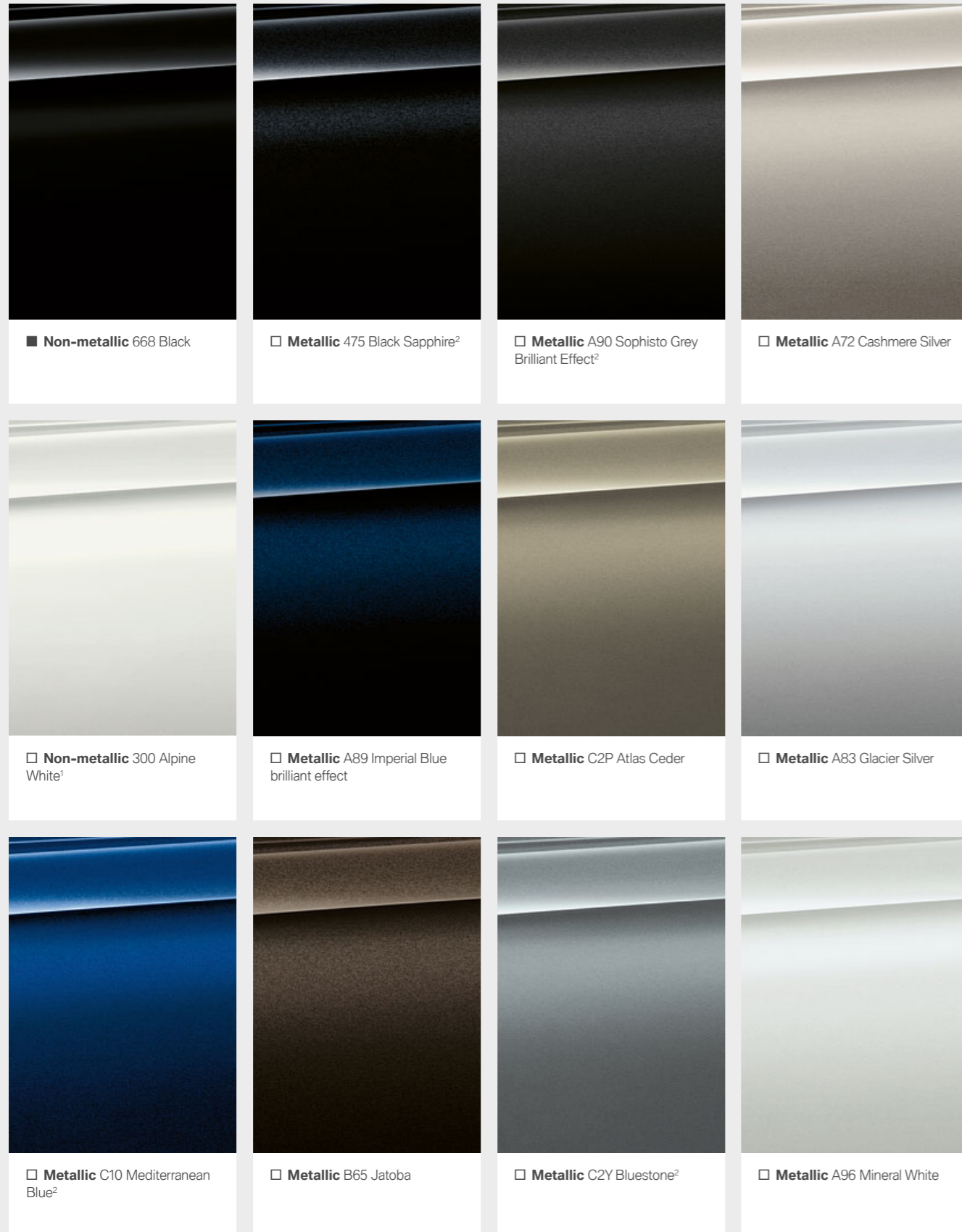

BMW INDIVIDUAL

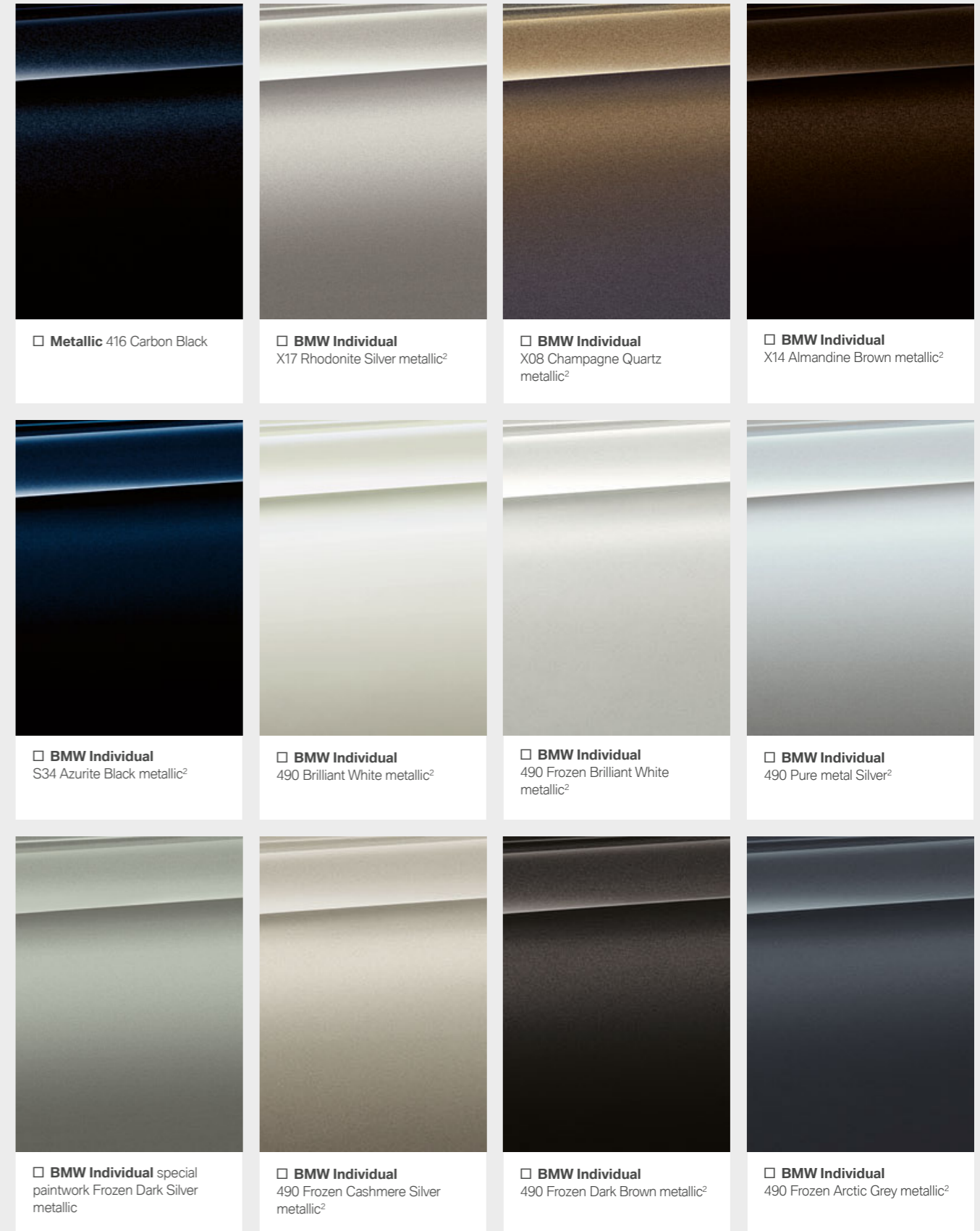

[Colours] The colours printed above are intended to provide you with a first impression of paints and materials available for your BMW. Experience has shown, however, that printed images of paint, upholstery and interior trim colours cannot faithfully reproduce the actual

appearance of the originals. We recommend therefore that you consult your BMW partner who will be able to show you original samples and assist with special requests.

¹ Also available as standard equipment for M Sport package.

² Optionally available for the M Sport package.

INTERIOR COLOURS.

Discover more with the new BMW catalogue app. Now available for your smartphone and tablet.

■ Standard equipment □ Optional equipment

CLOTH Available with

- Basic

Cloth Junction
BYAT Anthracite¹



CLOTH/LEATHER COMBINATION Available with

- Sport Line

Plectoid cloth/leather upholstery
CNAT Anthracite



- M Sport package

Rhombic cloth/Alcantara upholstery
HRAT Anthracite^{6,9}



LEATHER Available with

- Basic
- Luxury Line
- Sport Line
- M Sport package

Dakota leather
LCSW Black

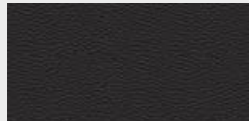

- Basic
- Luxury Line
- Sport Line
- M Sport package

Dakota leather
LCCY Canberra Beige², interior colour Canberra Beige



- Basic
- Luxury Line
- Sport Line
- M Sport package

Dakota leather
LCEW Ivory White, interior colour Black

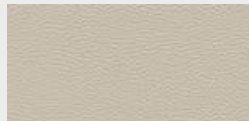

- Basic
- Luxury Line
- Sport Line
- M Sport package

Dakota leather
LCRI Cognac



- Luxury Line
- Sport Line
- M Sport package

Dakota leather
LCFK Black³ with exclusive stitching, contrast piping



- Luxury Line
- Sport Line
- M Sport package

Dakota leather
LCDO Canberra Beige⁹ with exclusive stitching, contrast piping



LEATHER Available with

- Luxury Line
- Sport Line
- M Sport package

Dakota leather
LCFI Ivory White⁹ with exclusive stitching, contrast piping



- Luxury Line
- Sport Line
- M Sport package

Dakota leather
LCFF Ivory White⁹ with exclusive stitching, contrast piping



- Luxury Line
- Sport Line
- M Sport package

Dakota leather
LCRO Cognac⁹ with exclusive stitching, contrast piping

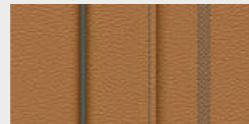

- Luxury Line
- Sport Line
- M Sport package

Dakota leather
LCTJ Night Blue with exclusive stitching^{3,9}, contrast piping



- M Sport package

Dakota leather
LCNL Black with contrast stitching in Blue^{6,8}

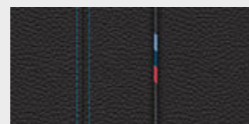

- Luxury Line
- Sport Line
- M Sport package

Exclusive Nappa leather
LZFK Black with exclusive stitching, contrast piping



- Luxury Line
- Sport Line
- M Sport package

Exclusive Nappa leather Dakota
LZFI Ivory White with exclusive stitching, contrast piping

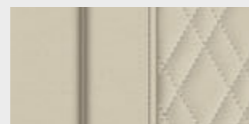

- Luxury Line
- Sport Line
- M Sport package

Exclusive Nappa leather
LZFF Ivory White with exclusive stitching, contrast piping



- Luxury Line
- Sport Line
- M Sport package

Exclusive Nappa leather
LZNI Mocha with exclusive stitching, contrast piping

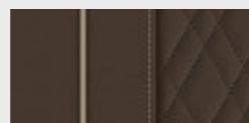

INTERIOR COLOURS Available with

- Basic
- Luxury Line
- Sport Line
- M Sport package

Black with headliner in Ivory White

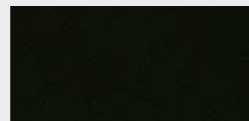

- Basic
- Luxury Line
- Sport Line
- M Sport package

Canberra Beige with headliner in Canberra Beige



INTERIOR TRIMS Available with

- Basic

4K8 Oxide Silver dark matt with Pearl-Gloss Chrome accent lines



- M Sport package

4K7 Aluminium rhombic with Pearl-Gloss Chrome accent trim



- Basic
- Luxury Line
- Sport Line
- M Sport package

4K9 Fine Brushed Aluminium with Pearl-Gloss Chrome accent lines



- Basic
- Luxury Line
- Sport Line

4LU Black high-gloss with Pearl Chrome highlights



- Basic
- Luxury Line
- Sport Line
- M Sport package

4LH Finline Cove fine-wood trim with Pearl-Gloss Chrome accent lines



- Basic
- Luxury Line
- Sport Line
- M Sport package

4LF Finline Ridge fine-wood trim with Pearl-Gloss Chrome accent lines

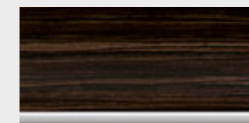

- Basic
- Luxury Line
- Sport Line
- M Sport package

4LG Burled Walnut dark fine-wood trim with Pearl-Gloss Chrome accent lines

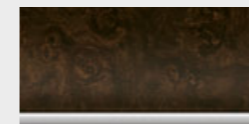

- Basic
- Luxury Line
- Sport Line
- M Sport package

4LQ Poplar grain fine-wood trim with Pearl-Gloss Chrome accent lines

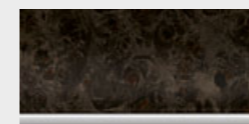

BMW INDIVIDUAL HEADLINER Available with

- Basic
- Luxury Line
- Sport Line
- M Sport package

BMW Individual headliner
775 Anthracite

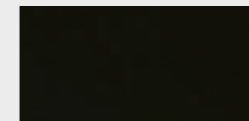

BMW INDIVIDUAL UPHOLSTERY COLOURS Available with

- Basic
- Luxury Line
- Sport Line
- M Sport package

BMW Individual Full Leather Merino
ZBFU Smoke White^{4,5}



- Basic
- Luxury Line
- Sport Line
- M Sport package

BMW Individual Full Leather Merino
ZBCR Caramel^{4,5}



- Basic
- Luxury Line
- Sport Line
- M Sport package

BMW Individual Full Leather Merino
ZBTQ Tartufo^{4,5}

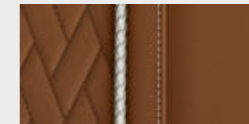

BMW INDIVIDUAL INTERIOR TRIMS

- Basic
- Luxury Line
- Sport Line
- M Sport package

BMW Individual interior trim
XEW Fine-wood trim Sen Light Brown⁷



- Basic
- Luxury Line
- Sport Line
- M Sport package

BMW Individual interior trim
4WY Fine-wood trim Plum Brown high-gloss⁷



- Basic
- Luxury Line
- Sport Line
- M Sport package

BMW Individual interior trim
4ML Piano finish Black⁷



Please note that even normal long or short-term use can lead to permanent upholstery damage. This can be caused in particular by non-colourfast clothing.

The interior colour is dependent on the chosen upholstery colour.

¹ Only available in conjunction with standard seats.

² Not available in conjunction with sport seats.

³ Not available in conjunction with standard seats.

⁴ Includes leather-covered instrument panel, top in Nappa leather in Black with contrast stitching and bottom in fine-grain Merino leather matching the seat upholstery colour.

⁵ Also available as BMW Individual extended fine-grain Merino leather upholstery.

⁶ Seats with M signature in the piping.

⁷ With Pearl-Gloss Chrome accent line.

⁸ Only available in conjunction with Sport seats.

⁹ Not available in conjunction with Active seat ventilation, front.

WHEELS AND TYRES.

Discover more with the new BMW catalogue app. Now available for your smartphone and tablet.



□ 20" BMW Individual light alloy wheels V-spoke style 759 I Bicolor, front wheel size 8J x 20, tyres 245/35 R20, rear wheel size 9J x 20, tyres 275/30 R20.



□ 19" light alloy wheels W-spoke style 663 Ferric Grey gloss-lathed with mixed tyres and run-flat properties, front 8J x 19 with 245/40 R19 tyres, rear 9J x 19 with 275/35 R19 tyres.



□ 17" light alloy wheels turbine style 645 in Bicolour Orbit Grey, gloss-lathed, BMW EfficientDynamics, 7.5J x 17, with 225/55 R17 tyres.



□ 17" light alloy wheels V-spoke style 631 Ferric Grey gloss-lathed, 7.5J x 17 with 225/55 R17 tyres.



□ 18" light alloy wheels Multi-spoke style 619, 8J x 18 with 245/45 R18 tyres.



□ 19" M light alloy wheels Double-spoke style 664 M Jet Black non-metallic¹, with run-flat properties and mixed tyres, front 8J x 19 with 245/40 R19 tyres, rear 9J x 19 with 275/35 R19 tyres.



□ 18" light alloy wheels V-spoke style 684 Ferric Grey gloss-lathed, 8J x 18 with 245/45 R18 tyres.



○ 20" M light alloy Double-spoke style 669 M wheels, Bicolour with mixed tyres and runflat properties, front wheel size 8J x 20 with tyres 245/35 R20, rear wheel size 9J x 20 with tyres 275/30 R20.



○ 20" light alloy wheels Cross-spoke style 636 in Bicolor Orbit Grey, bright turned on the visible side. TPMS complete wheel set with run-flat mixed tyres, wheel size 8J x 20 and 9J x 20.

ORIGINAL BMW ACCESSORIES.

Equipment 40 | 41

■ Standard equipment □ Optional equipment ○ Accessories



○ The modern roof box in Black and Titanium Silver side trims has a capacity of 520 litres and is compatible with all BMW roof rack systems. Thanks to the double-sided opening system and triple locking on both sides, the skis are easy to load and protected from theft.



○ The anti-slip, water-resistant and durable mat with raised borders protects the luggage compartment. Its perfect fit and black design dovetail perfectly with the BMW basic equipment and features a tab for removing the mat as well as the number 5 in the form of a high-quality stainless steel inlay.

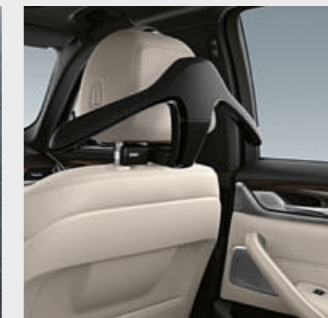

○ Travel & Comfort System – base carrier. Provides an option to attach clothes hangers, a folding table, universal hooks or holders for GoPro cameras, iPads™ or Samsung Galaxy Tabs to the front seat headrest.



○ Firm hold for tablets with BMW safety case. The adjustable holder is attached to the basic carrier or to the optional equipment "Travel & Comfort".

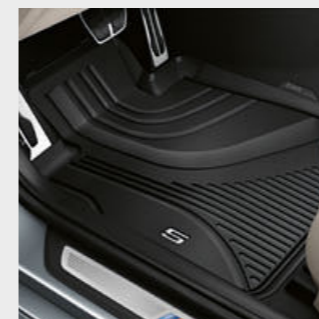

○ All-weather floor mats – precision-fit protection from damp, dirt and waterlogging in entire footwell. The black finish is a perfect match with the interior.

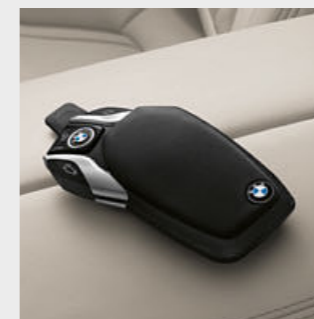

○ BMW Display Key Case – the precision-fit case made from Nappa leather protects the BMW display key.

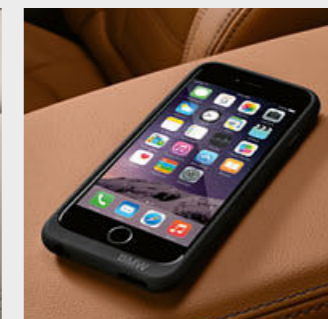

○ Wireless charging case for recharging Apple iPhone™ models 5/5s/SE/6/6s via induction without a cable; mobile phone case also serves as protective case.



○ The high-quality travel blanket with a beige and a dark brown side is made from 100 percent extra-fine Merino wool and is woven using the Jacquard-technique.

¹ Only available in conjunction with the M Sport package.

Discover the all-round innovative solutions on offer in many categories: exterior, interior, communication & information and transport & luggage compartment. Your BMW partner will be happy to advise you and provide you with a special catalogue detailing the entire

range of Original BMW Accessories. For further information, please visit www.bmw.com/accessories

BMW 5 Series Saloon	520i	530i 530i xDrive	540i 540i xDrive	518d	520d 520d xDrive	525d	530d 530d xDrive	540d xDrive	M550d xDrive	530e iPerformance
---------------------	------	---------------------	---------------------	------	---------------------	------	---------------------	-------------	--------------	----------------------

Gewicht											
Unladen weight EU ¹	kg	[1615]	[1615]	[1670]	[1655]	1615 [1670]	[1670]	[1715]	-	-	[1845]
Unladen EU ¹ (xDrive)	kg	-	[1680]	[1735]	-	[1725]	-	[1770]	[1810]	[1920]	-
Max. permissible	kg	[2210]	[2200]	[2270]	[2260]	2230 [2270]	[2295]	[2345]	-	-	[2420]
Max. permissible weight (xDrive)	kg	-	[2280]	[2340]	-	[2330]	-	[2385]	[2440]	[2470]	-
Permitted load	kg	[670]	[680]	[675]	[680]	685 [675]	[700]	[705]	-	-	[650]
Permitted load (xDrive)	kg	-	[675]	[675]	-	[680]	-	[690]	[705]	[625]	-
Permitted trailer load, unbraked ²	kg	[750]	[750]	[750]	[750]	750 [750]	[750]	[750]	-	-	- ⁹
Permitted trailer load, unbraked (xDrive) ²	kg	-	[750]	[750]	-	[750]	-	[750]	[750]	-	-
Permitted trailer load, braked, max. 12% gradient/max. 8% gradient ²	kg	[2000/2000]	[2000/2000]	[2000/2000]	[2000/2000]	1800/1800 [2000/2000]	[2000/2000]	[2000/2000]	-	-	- ⁹
Permitted trailer load, braked, max. 12% gradient/max. 8% gradient (xDrive) ²	kg	-	[2000/2000]	[2000/2000]	-	[2000/2000]	-	[2000/2000]	[2000/2000]	-	-
Luggage compartment capacity	l	530	530	530	530	530	530	530	530	410	

Engine ^{3,5}											
Cylinders/valves		4/4	4/4	6/4	4/4	4/4	4/4	6/4	6/4	6/4	4/4
Capacity	cm ³	1998	1998	2998	1995	1995	1995	2993	2993	2993	1998
Rated output/rated engine speed	kW (hp)/1/min	135 (184)/5000-6500	185 (252)/5200-6500	250 (340)/5500-6500	110 (150)/4000	140 (190)/4000	170 (231)/4400	195 (265)/4000	235 (320)/4400	294 (400)/4400	135 (184)/5000-6500
Max. torque/engine speed	Nm/1/min	290/1350-4250	350/1450-4800	450/1380-5200	350/1750-2500	400/1750-2500	500/2000	620/2000-2500	680/1750-2250	760/2000-3000	290/1350-4250

Power transmission											
Drive configuration		Rear-wheel	Rear-wheel/all-wheel	Rear-wheel/all-wheel	Rear-wheel	Rear-wheel/all-wheel	Rear-wheel	Rear-wheel/all-wheel	All-wheel	All-wheel	Rear-wheel
Standard transmission		8-speed Steptronic	8-speed Steptronic	8-speed Steptronic	8-speed Steptronic	6-speed manual	8-speed Steptronic	8-speed Steptronic	-	-	8-speed Steptronic
Standard transmission (xDrive)		-	8-speed Steptronic	8-speed Steptronic	-	8-speed Steptronic	-	8-speed Steptronic	8-speed Steptronic	8-speed Steptronic Sport	-

Performance											
Top speed	km/h	[235]	[250] ⁵	[250] ⁵	[220]	238 [235]	[250] ⁵	[250] ⁵	-	-	[235]
Top speed (xDrive)	km/h	-	[250] ⁵	[250] ⁵	-	[232]	-	[250] ⁵	[250] ⁵	[250] ⁵	-
Top speed, electric	km/h	-	-	-	-	-	-	-	-	-	[140]
Acceleration 0-100 km/h	s	[7.8]	[6.1]	[5.1]	[8.8]	7.7 [7.3]	[6.6]	[5.7]	-	-	[6.2]
Acceleration (xDrive) 0-100km/h	s	-	[6.0]	[4.8]	-	[7.3]	-	[5.4]	[4.7]	[4.4]	-

Consumption ^{3,4} - All engines conform to the EU6 standard											
Urban	l/100 km	[6.9-7.0]	[7.2-7.4]	[9.3-9.7]	[5.0-5.3]	5.3-5.6 [5.0-5.1]	[5.6-6.0]	[6.1-6.4]	-	-	-
Urban (xDrive)	l/100 km	-	[7.8-7.9]	[10.2-10.3]	-	[5.3-5.5]	-	[6.5-6.7]	[6.9-7.1]	[7.9-8.0]	-
Extra-urban	l/100 km	[5.1-5.14]	[5.0-5.3]	[5.8-6.0]	[4.1-4.2]	4.1-4.4 [4.1-4.3]	[4.4-4.6]	[4.3-4.6]	-	-	-
Extra urban (xDrive)	l/100 km	-	[5.3-5.6]	[6.2-6.4]	-	[4.4-4.6]	-	[4.7-5.0]	[5.0-5.2]	[5.7-5.8]	-
Combined	l/100 km	[5.8-6.0]	[5.8-6.1]	[7.1-7.4]	[4.4-4.6]	4.5-4.8 [4.5-4.6]	[4.9-5.1]	[5.0-5.2]	-	-	[2.1-2.3]
Combined (xDrive)	l/100 km	-	[6.2-6.5]	[7.7-7.9]	-	[4.7-4.9]	-	[5.3-5.6]	[5.7-5.9]	[6.5-6.6]	-
Energy consumption ⁶ 100 km		-	-	-	-	-	-	-	-	-	[13.3-13.9]
Exhaust emissions standard (type-certified)		[EU6d-temp]	[EU6d-temp]	[EU6d-temp]	[EU6d-temp]	EU6c [EU6d-temp]	[EU6c]	[EU6c]	[EU6c]	[EU6c]	- ⁹
Combined CO ₂ emissions	g/km	[132-137]	[132-139]	[161-168]	[116-122]	119-127 [117-121]	[128-135]	[131-138]	-	-	[52-47]
Combined CO ₂ emissions (xDrive)	g/km	-	[142-147]	[174-179]	-	[124-129]	-	[141-147]	[149-156]	[171-173]	-
Tank capacity (approx.)	l	68	68	68	66	66	66	66	66	66	46

BMW 5 Series Saloon	520i	530i 530i xDrive	540i 540i xDrive	518d	520d 520d xDrive	525d	530d 530d xDrive	540d xDrive	M550d xDrive	530e iPerformance
---------------------	------	---------------------	---------------------	------	---------------------	------	---------------------	-------------	--------------	----------------------

Wheels/tyres											
Tyre dimensions		225/55 R 17 Y	225/55 R 17 Y	225/55 R 17 Y	225/55 R 17 Y	225/55 R 17 Y	225/55 R 17 Y	225/55 R 17 Y	225/55 R 17 Y	245/40 R 19 Y ¹ /275/35 R 19 Y	225/55 R 17 Y
Wheel dimensions		7.5 J x 17	7.5 J x 17	7.5 J x 17	7.5 J x 17	7.5 J x 17	7.5 J x 17	7.5 J x 17	7.5 J x 17	8 J x 19 ¹ /9 J x 19	7.5 J x 17
Material		light alloy	light alloy	light alloy	light alloy	light alloy	light alloy	light alloy	light alloy	light alloy	light alloy

iPerformance system output											
Peak output/engine speed	kW (hp)/rpm	-	-	-	-	-	-	-	-	-	83 (113)/3170
System output	kW (hp)	-	-	-	-	-	-	-	-	-	185 (252)
System torque	Nm	-	-	-	-	-	-	-	-	-	420

High-voltage battery capacity											
Battery type/net battery capacity	kWh	-	-	-	-	-	-	-	-	-	8
Electric range (NEDC) ⁷ /Maximum overall range, combined ⁷	km	-	-	-	-	-	-	-	-	-	45-48/650
Charge time ⁸ (with household socket/BMW i Wallbox Pure/Pro)	h	-	-	-	-	-	-	-	-	-	3:50/2:50

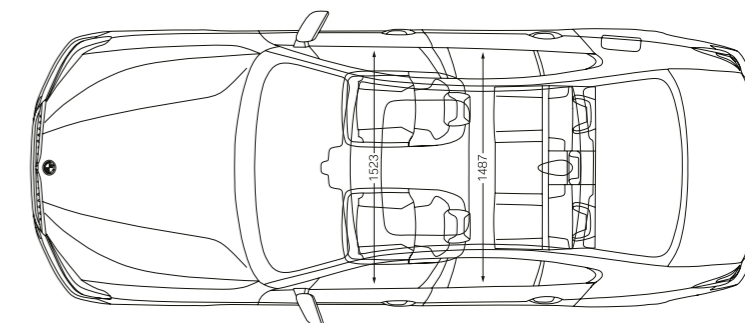
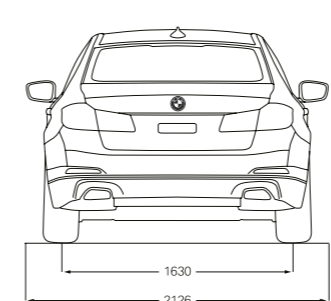
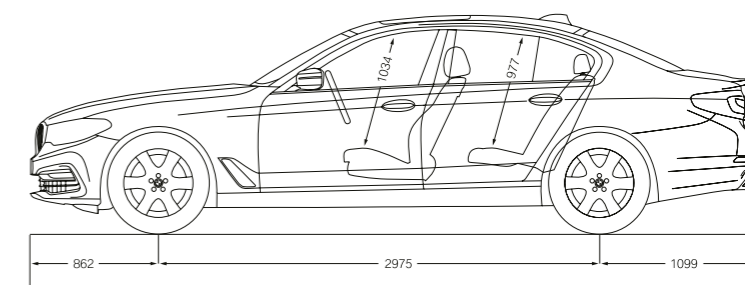
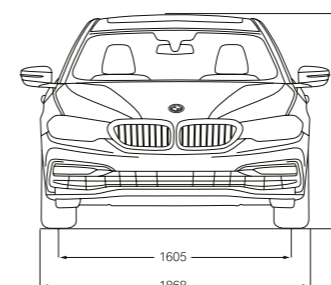

All dimensions in the technical drawings are given in millimetres. Height without roof aerial is 1466mm.

¹ The EC unladen weight refers to a vehicle with standard equipment and does not include any optional extras. The unladen weight includes a 90% full tank and a driver weight of 75 kg. Optional equipment may affect the weight of the vehicle, the payload and the top speed if the selected equipment has an impact on the vehicle's aerodynamics.

² The actual total weight of the trailer must not exceed the maximum trailer load, taking into account the maximum tow bar download.

³ Performance data of petrol engines apply to vehicles using RON 98 fuel. Fuel consumption data apply to vehicles using reference fuels in accordance with EU Regulation 2007/715. Unleaded RON 91 and higher with a maximum ethanol content of 10% (E10) may also be used. BMW recommends RON 95 super unleaded petrol.

⁴ The data for fuel consumption, CO₂ emissions and energy consumption are determined in accordance with the measurements processes as defined by European Regulation (EU) 2007/715 in the applicable version. Data refer to a vehicle with base-level equipment in Germany, and the ranges account for differences according to the selected wheel and tyre size and the optional equipment and may change during the configuration process. Figures have been determined on the basis of the new WLTP test cycle and have been converted back into NEDC figures for comparability. For these vehicles, values other than those specified here may apply for the assessment of taxes and other vehicle-related charges that are (also) based on CO₂ emissions.

⁵ Electronically limited.

⁶ The combined energy consumption depends on the selected wheel and tyre sizes.

⁷ Range depends on various factors. In particular: personal driving style, route characteristics, exterior temperature, heating/air conditioning, pre-conditioning.

⁸ Dependent on the local electricity infrastructure. Charging time corresponds to a 100% charge of maximum capacity.

⁹ Provisional figures; any missing figures were unavailable at the time of publication.

BMW 540i SALOON WITH M SPORT PACKAGE:

BMW TwinPower Turbo 6-cylinder inline petrol engine, 250 kW (340 hp), 20" BMW Individual light alloy wheels V-spoke style 759 I Bicolor with mixed tyres, exterior colour Bluestone metallic, seats Dakota Ivory White leather with exclusive stitching and contrast piping, interior trim in Finesline Ridge fine-wood with Pearl-Gloss Chrome accent line.

BMW 530e iPERFORMANCE:

BMW TwinPower Turbo 4-cylinder inline petrol engine (135 kW/184 hp), electric motor (70 kW/95 hp), 19" light alloy wheels V-spoke style 635 with mixed tyres, exterior colour Glacier Silver metallic, seats Dakota Night Blue leather with exclusive stitching and contrasting piping, BMW Individual Piano Black interior trim.

The models illustrated in this brochure show the equipment and configuration options (standard and optional) for vehicles produced by BMW AG for the German market. Alterations in standard and optional equipment and the configurations available for the different models, as described in this brochure, may occur after 03/16/2018, the date when this brochure went to press, or according to the specific requirements of other markets. Your local BMW Partner is available to provide further details. Subject to change in design and equipment.

© BMW AG, Munich, Germany. Not to be reproduced wholly or in part without prior written permission of BMW AG, Munich.

4 11 005 360 20 2 2018 BC. Printed in Germany 2018.

